

ELS Catalogue 2.0

# Helios mono tube ventilation system. ultraSilence® ELS.

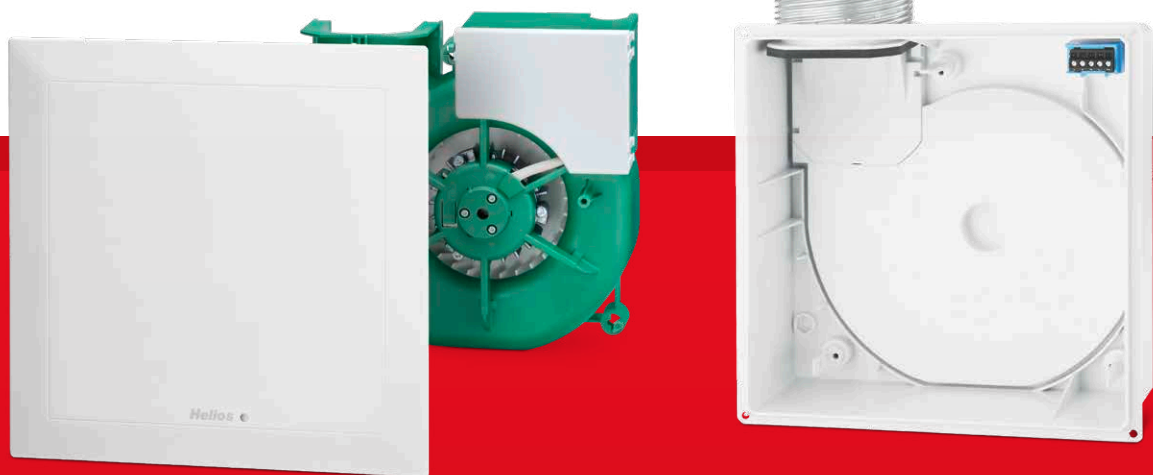

The best of  
mono tube ventilation  
systems.



02

22

26

36

# ELS.

- 02 100 % ELS.
- 08 100 % Power and unique variety.
- 10 100 % Comfort through individual solutions.
- 12 100 % Convincing: Even more highlights.
  
- 14 No ventilation without rules.
- 18 Diameter determination for main lines.

# The Types.

- 24 ELS standard.
- 24 ELS with automatic humidity control.
- 25 ELS with overrun (adjustable).
- 25 ELS with motion sensor.

# The Casings.

- 26 ELS-GU: One casing. All the possibilities.
- 28 Quick selection.
- 30 Detailed selection.
- 34 Clever installation details.

# The Accessories.

- 37 ELS accessories for casings and fans.
- 39 Electrical accessories.
- 40 Inflow elements and air grilles.
- 42 The new supply air device ZLA 125.
- 44 Soffit element for supply air flow.
- 46 The perfect team: ELS and EcoVent Verso.
  
- 52 Wiring diagram overview.

# Powerful

+

# Quiet

+

# Attractive

+

# COM PACT

+

ENVIRONMENTALLY

FRIENDLY

= 100%  
ELS. 



**\* Helios has always set the standards for mono tube ventilation systems.**

On the one hand, through proverbial quality and reliability. And, on the other hand, through the sum of the outstanding properties, which has reached a practically unsurpassable standard in terms of model diversity and installation through to technical specifications. All this applies to the two variants of ultraSilence® ELS, both for the proven AC-Types as well as the even more economical EC-Versions.

Completely convincing with  
internal and external values.

## 100% Powerful.

ultraSilence® ELS truly generates pressure. 260 Pa at 60 m³/h, in fact. This is not only record-breaking, it also allows the smallest pipe cross-sections for the main line and thereby increases the possible living space.

## 100% Quiet.

With so much power, it is quite astonishing that ultraSilence® ELS is so quiet. 35 dB(A) at  $V = 60 \text{ m}^3/\text{h}^*$  is on the threshold of audibility and a value that nobody will beat.

\*( $L_{PA}$  at  $A_L = 10 \text{ m}^2$ )

## 100% Attractive.

Best design at any price: ultraSilence® ELS is unique and has received globally recognised awards.



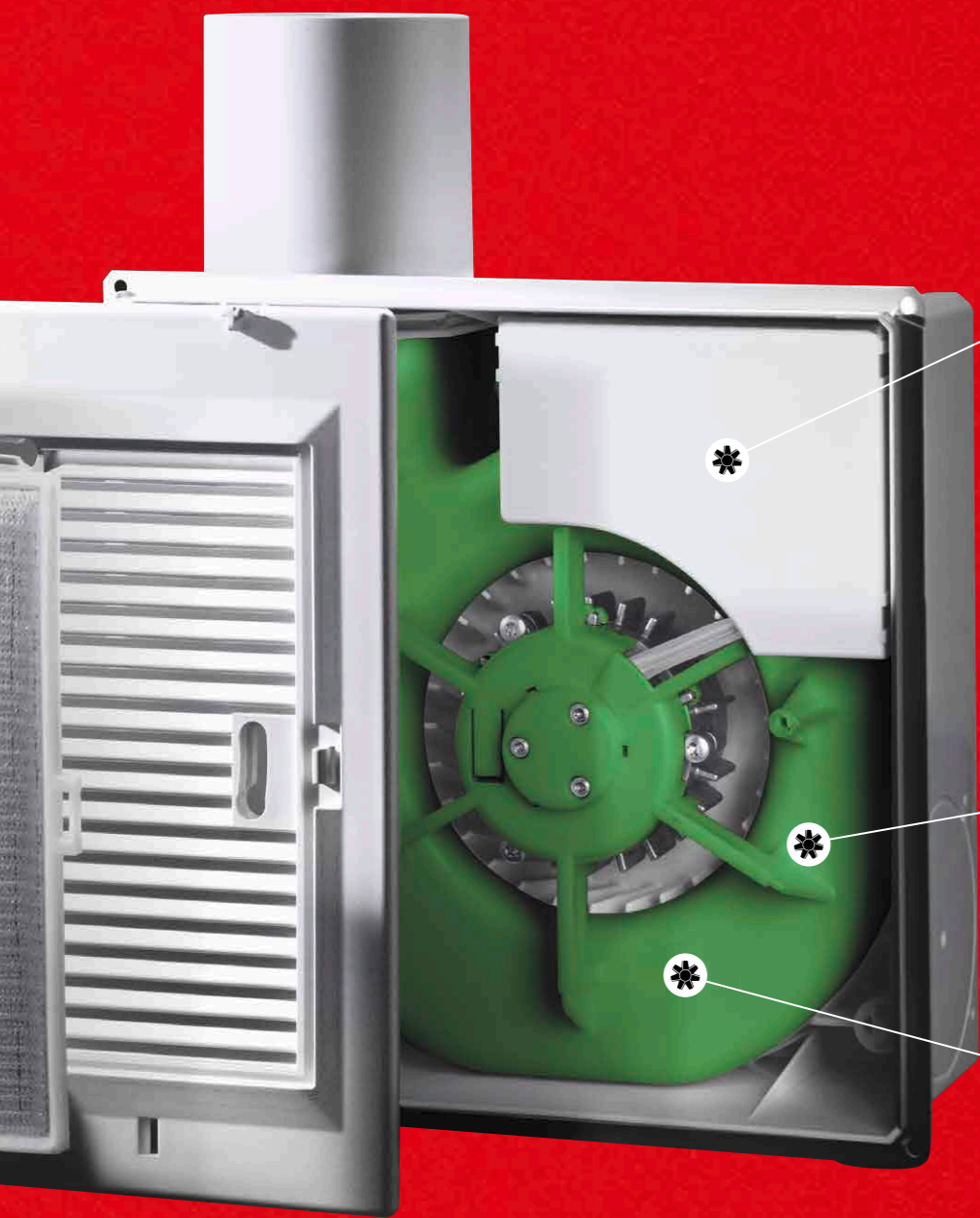

## 100% Compact.

The special achievement of a product sometimes lies in offering less: for example, with regard to the dimensions. In this respect, ultraSilence® ELS also holds the record with an installation depth of just 89 mm.



## 100% Environmentally friendly.

Beside our well-known AC-models, EC motors make the ultraSilence® ELS a veritable miracle of efficiency and reduce energy costs by up to 70 %.

## 100% Made in Germany.

There is no substitute for quality and innovative strength. The Helios brand stands for both like no other. Thus, our mono tube ventilation systems, from the motor and control technology through to the impeller, are completely developed and produced in Germany. You can count on this.

**Unique:** The impeller developed by Helios generates a lot of pressure almost inaudibly.





# 100 % Power and unique variety.

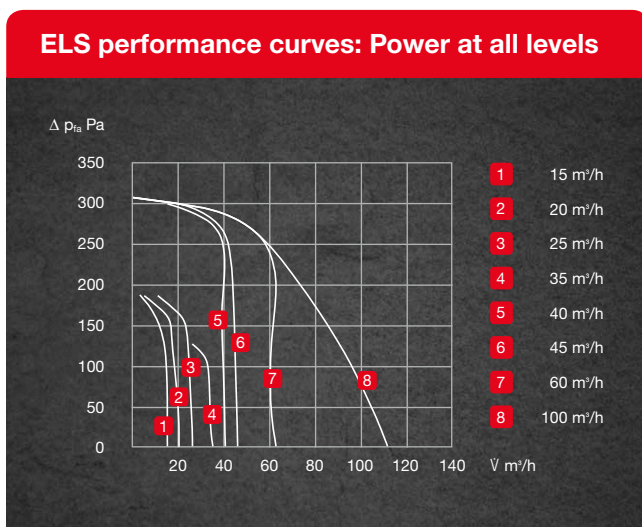

## Ultra-powerful and ultra-quiet.

More power and less noise – ultraSilence® ELS combines all the ingredients for a perfectly balanced ventilation system. This includes an extremely economic drive, which is also available with EC technology and up to 70 % energy savings upon request. Furthermore, the impeller specially developed by Helios for ELS ensures the highest pressure performance with minimal noise level.

The result is optimal values in all ventilation stages, which fully cover all requirements there may be in the area of standards DIN 18017-3 and DIN 1946-6:

- 40/60 m³/h
- 40/15/60 m³/h
- 40/20/60 m³/h
- 45/25/60 m³/h
- 60 m³/h
- 60/15 m³/h
- 60/35 m³/h
- 60/40/15 m³/h
- 60/45/25 m³/h
- 100 m³/h
- 100/35 m³/h
- 100/60 m³/h
- 100/60/35 m³/h

## Order, install, ready.

ultraSilence® ELS is based on a sophisticated overall concept with the aim of making planning and installation as easy as possible. It therefore always guarantees precise design and it comes pre-configured for maximum planning reliability and functional guarantee.

This results in two more advantages:

- The subsequent manipulation of the flow rate advertised by the planner is ruled out.
- ELS is immediately ready for use. There is no laborious programming on-site.

Every ELS fan fits in every casing.

In addition, all types – whether AC or EC – share a joint approval. This unique compatibility makes the subsequent, quick and simple replacement possible. For example, this is ideal in the context of modernisation work.

# 100% Comfort through individual solutions.

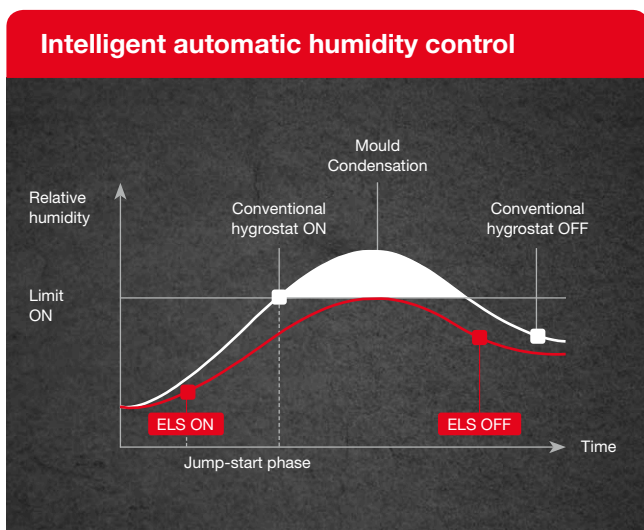

## Perfect ventilation, tailored to the requirements.

In addition to the types ELS standard and ELS with (adjustable) overrun, the variants with motion sensor and automatic humidity control offer maximum comfort and completely barrier-free, automatic operation.

### ELS with motion sensor.

These ELS types are ideal for the ventilation of toilets and sanitary facilities in residential homes, hotels or offices. An integrated motion sensor ensures the automatic operation of the ventilation unit when a room is entered without switch actuation. If the impulse is repeated during this time, the operating period will extend accordingly. When the room is empty again, there will be an overrun time which can be additionally configured for ELS EC. Practical for planning and installation: The electrical connection simply uses the nearest socket.

### ELS with automatic humidity control.

First and foremost, the solutions with humidity control are ideal for bathrooms and shower rooms. In contrast to conventional hygrostats, ELS is equipped with a particularly intelligent and effective logic for early moisture detection. If desired, this will immediately activate at a high ventilation stage when the humidity begins to increase and it reacts to different types of humidity increase.

With regard to a normal humidity increase, for example, due to normal washing, the fan will activate when the defined limit is reached and run until the room air humidity has dropped by around 10%.

With regard to a fast humidity increase, for example, due to showering, the fan will activate before reaching the limit and thus prevents excessive humidity at an early stage and quickly. Furthermore, the dynamic humidity control is able to differentiate real humidity increases from external disturbances – for example, such as weather-related high air humidity.

**Barrier-free and fully automatic,** the ELS types operate with motion sensors or automatic humidity controls.

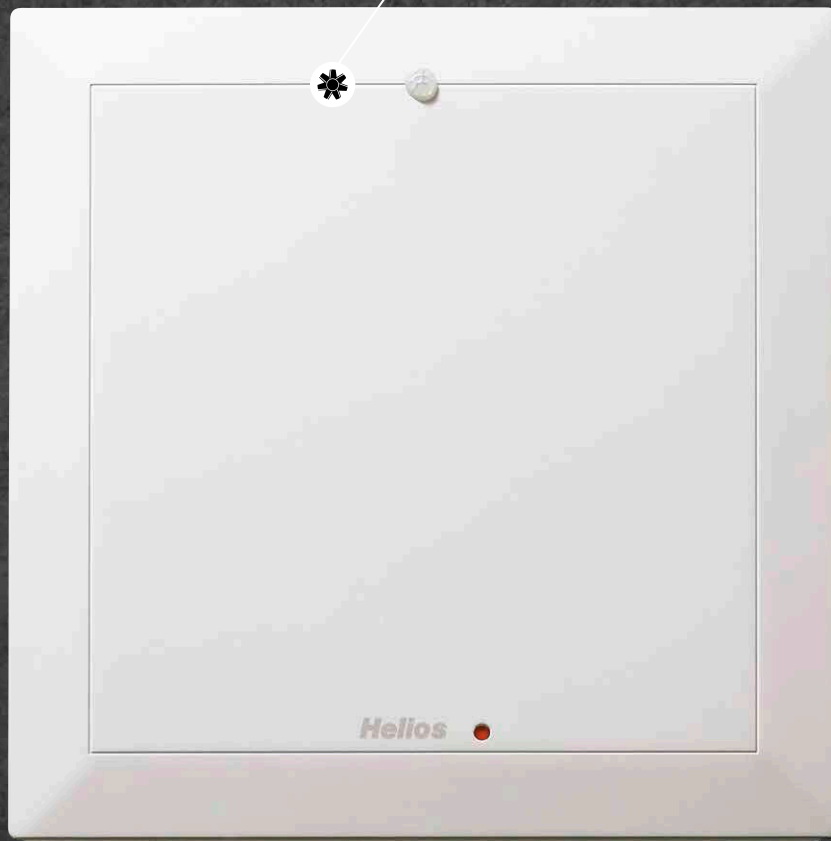

# 100% Convincing: Even more highlights.



Every trick in the book:  
All ELS types are equipped with  
a permanent filter, which can be  
easily cleaned in the dishwasher.

## ELS in wetrooms



ELS is optimally protected against humidity: Installation in wetroom zone 1 according to DIN VDE 0100-701 is possible without difficulty.

From simple installation and maintenance and intelligent electronics through to the various test marks and approvals – Helios ELS meets all practical requirements and every request for comfort and highest performance.

**Universal:** Optimal solution for all requirements – more than 60 different ELS fans can be used with one turn of the hand, without tools, in the same surface/flush-mounted casing.

**Quick:** It couldn't be easier – the electrical plug connection can be removed from its holder for convenient connection. Cable insertion and coupling connection take place during casing installation.

**Clever:** The airtight backdraught shutter integrated in the discharge spigots can be turned in 90° increments. This allows a casing position with discharge to the left, right, top or back.

**Flexible:** Flexibility without limits: Casing types ELS-GU and -GUBA for single room or two room ventilation with connection to the left, right, bottom or for WC connection. Discharge spigots to the top, left, right or back.

**Unique:** The filter cleaning indicator signals contamination. The large-surface permanent filter is dishwasher safe and saves the purchase of expensive throwaway filters.

**Safe:** The ultraSilence® ELS range is approved by the German Institute for Building Technology (DIBt, Z-51.1-193) and bears international test marks. It complies with the relevant standards and regulations. It also has the following test certificates:

- German TÜV-tested performance curve
- Sound insulation in building construction (DIN 4109), tested by the Institute for Acoustics and Building Physics (IAB), Oberursel
- German TÜV-tested air leak rate of backdraught shutter
- External production monitoring by German TÜV Bavaria-Saxony
- Testing of fire protection damper and casings by the Material Testing Institute of the Institute for Building Material, Solid Construction and Fire Protection (IBMB) -Braunschweig-, Swiss Fire Protection Register Z 5491



# No ventilation without rules.

Domestic ventilation is neither arbitrary nor voluntary – there are clear rules and regulations. E.g. two standards define the essential requirements in Germany:

- **DIN 18017-3**
- **DIN 1946-6**

**DIN 18017-3** is a German standard, which is also recognized in several countries, introduced under building law and thus regulates the extract ventilation of internal bathrooms and WCs in residential units, hotels and other buildings. It stipulates that sanitary facilities without windows fundamentally require **mechanical ventilation**. Unwanted odours or moisture must be discharged if necessary, and irrespective of whether it is a residential building (bathroom, WC, kitchen, storage rooms) or e.g. internal WCs in office buildings.

In contrast, **DIN 1946-6** regulates the ventilation of entire residential units and is not only limited to e.g. sanitary facilities in residential buildings; non-residential buildings are excluded. The objective of the standard is to ensure that there is a **constant, user-independent and defined minimum air exchange** (ventilation for moisture protection).

## **DIN 18017-3 and its areas of application.**

The area of application of DIN 18017-3 focuses on the operational area of extract ventilation systems for:

- Internal bathrooms and toilets (without windows).
- Kitchens and kitchenettes with windows, storage rooms etc.
- Internal sanitary facilities and office kitchenettes in multi-storey buildings.

Distinctions are drawn between: the following systems

## Single ventilation systems with own extract air lines, e.g. Helios MiniVent® M1, ultraSilence® ELS

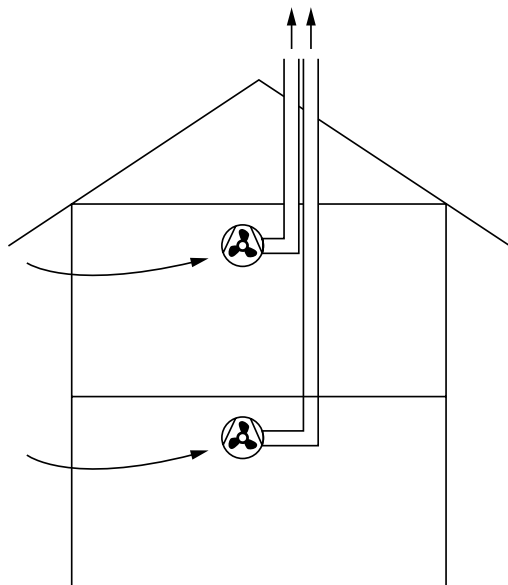

- Often used in applications with up to two full floors.
- Without fire protection requirements.



## Mono tube ventilation systems with shared extract air line, e.g. Helios ultraSilence® ELS

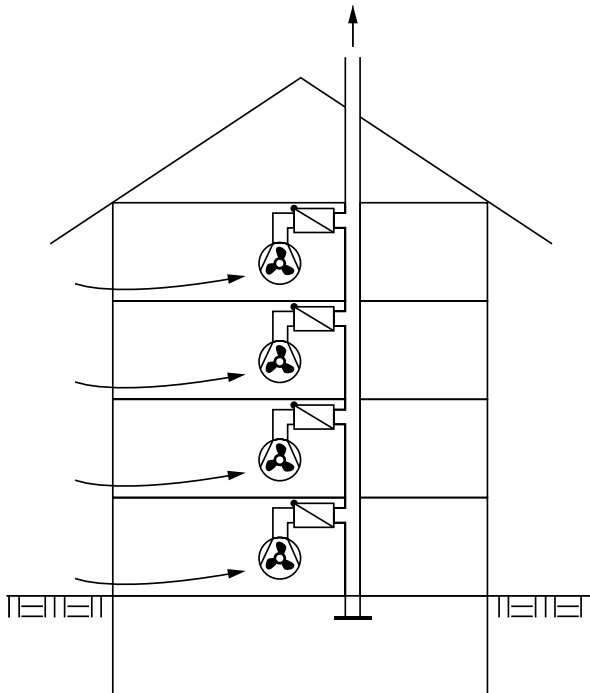

- Usually used for more than two full floors.
- Realisation of different fire protection concepts.
- Planning and cost advantages due to the shared main line.



## Central ventilation systems, e.g. Helios ZLS-DV EC

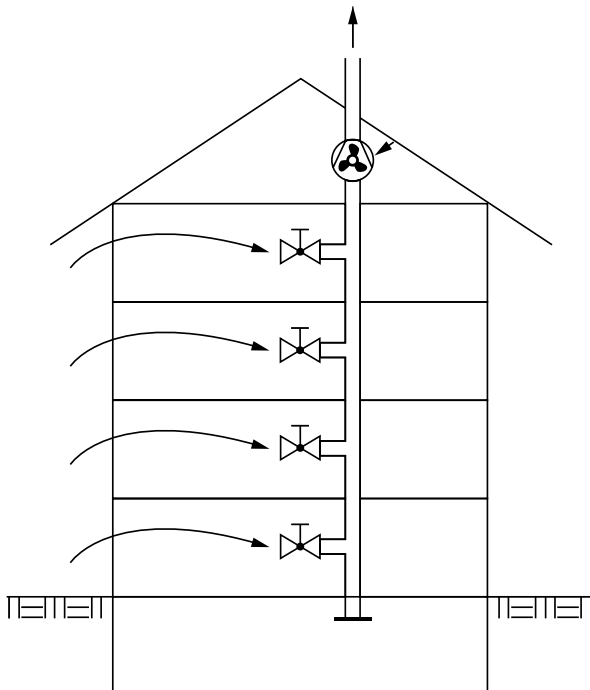

- Central ventilation systems are divided into systems with central, whereby the flow rate can be adjusted in the individual residential units.
- Central extract air fan at the end of the shared main line.



## ■ Basic ventilation and hygienic requirements.

### Extract air flow rates

#### Planned minimum flow rates

Ventilation units for the extract ventilation of bathrooms (as well as WCs, kitchens and storage rooms) can be designed for flow rates of 40 m<sup>3</sup>/h or 60 m<sup>3</sup>/h, depending on the model type and operating mode.

With regard to **WCs**, the planned flow rates can be **halved** under certain circumstances.

The table displays example configurations of flow rate and runtime, which are compliant with DIN 18017-3.

In accordance with DIN 18017-3, the flow rate may be reduced to 0 m<sup>3</sup>/h in times of low air requirement, provided the building complies with the heat insulation standard of the Heat Insulation Ordinance of 1995 or better.

Planned airflow		without use			in use		
Planned in m <sup>3</sup> /h	Runtime in hrs	Reduced in m <sup>3</sup> /h	Runtime in hrs	Comment	Planned in m <sup>3</sup> /h	Overrun in min.	Comment
<b>Bathroom and WC</b>							
40	24	–	–		40	–	
40	mind. 12	20	max. 12		40	–	
40	–	15	24	Can be regulated continuously between 40 and 15 m <sup>3</sup> /h, depending on the humidity; Continuous operation with sensor	40	–	
60	–	15	24	Continuous operation	60	–	
60	–	e.g. 30	12	Average interval over 24h = 15 m <sup>3</sup> /h. Max. Interval 1 h (fan OFF)	60	–	
60	–	0	–	PIR sensor + overrun or light switch + overrun	60	15	at 60 m <sup>3</sup> /h $\triangleq$ 1 m <sup>3</sup> /min. $\triangleq$ 15 min.
<b>For WC</b>							
20	24	–	–		20	–	
20	mind. 12	10	max. 12		20	–	
20	24	7,5	24	Continuous operation with sensor	20	–	Operation with sensor
30	–	7,5	24	Continuous operation	30	–	
30	–	15	12	Average interval over 24h = 7,5 m <sup>3</sup> /h. Max. Interval 1 h (fan OFF)			
30	–	0	–	PIR sensor + overrun	30	15	at 30 m <sup>3</sup> /h $\triangleq$ 0,5 m <sup>3</sup> /min. $\triangleq$ 15 min.



## Outside air backflow (supply air flow).

An equivalent supply air back flow must be ensured corresponding to the extract air flow rate. These requirements are fulfilled with appropriate outside air openings in the residential and recreation rooms as well as overflow openings for sanitary facilities.

The required air volume, which must flow in through the outside air openings, is calculated according to DIN 1946-6 in consideration of infiltration influences.

In order to ensure the flow in the extract air zones, non-lockable overflow openings must be installed. The necessary size and number of overflow openings results from the required overflow air flow rate.

If a ventilation measure is required for the building according to DIN 1946-6, the ventilation flow rates for moisture protection must at least be ensured user-independently and permanently.

### Example floor plan

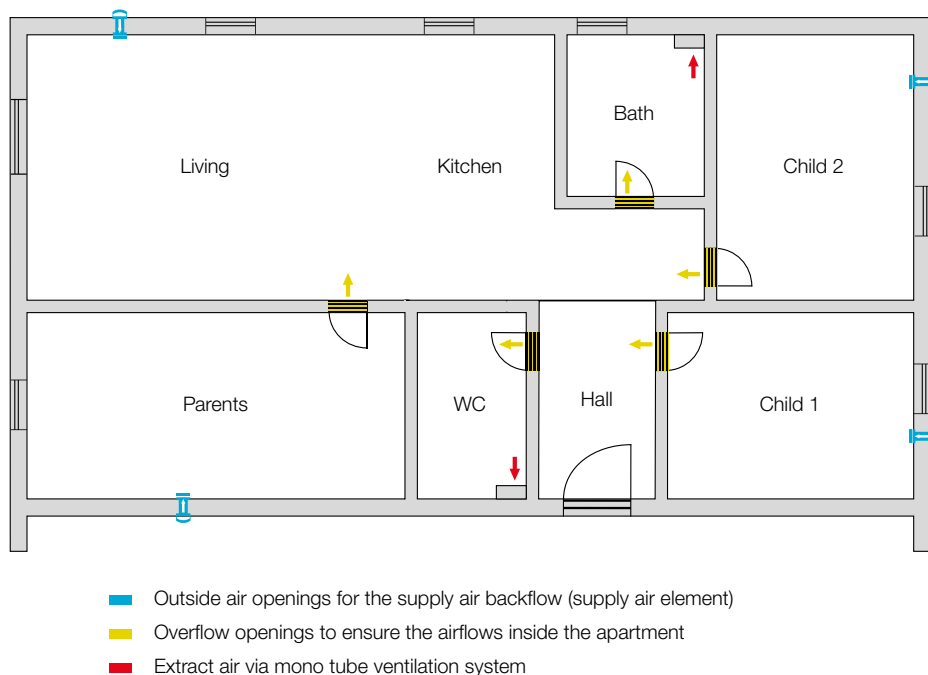

**Consequently:** With regard to system design according to DIN 18017-3, the flow rate for moisture protection pursuant to DIN 1946-6 must always be ensured by appropriate planning and design for reasons of liability.

**Solution:** A fan with two performance levels individually ensures that the two standards are always taken into account according to specific requirements.

**Example:** Helios ultraSilence® ELS mono tube ventilation system with two performance levels: ELS-V 60/35.

ELS-V 60/35 has performance levels 60 m<sup>3</sup>/h and 35 m<sup>3</sup>/h. The low performance level can be connected for permanent operation and thus meets all requirements of DIN 1946-6. Demand-controlled ventilation according to DIN 18017-3 is guaranteed by the high performance level and can be activated manually e.g. via the light switch.

**Expert tip:** The multilevel ELS also comes with convenient automatic functions. Thus, demand-controlled ventilation according to DIN 18017-3 can be automatically activated without user interaction using motion sensors or automatic humidity controls –with an individually programmable overrun time if required!

Now you can easily determine **the diameter of the main line.**

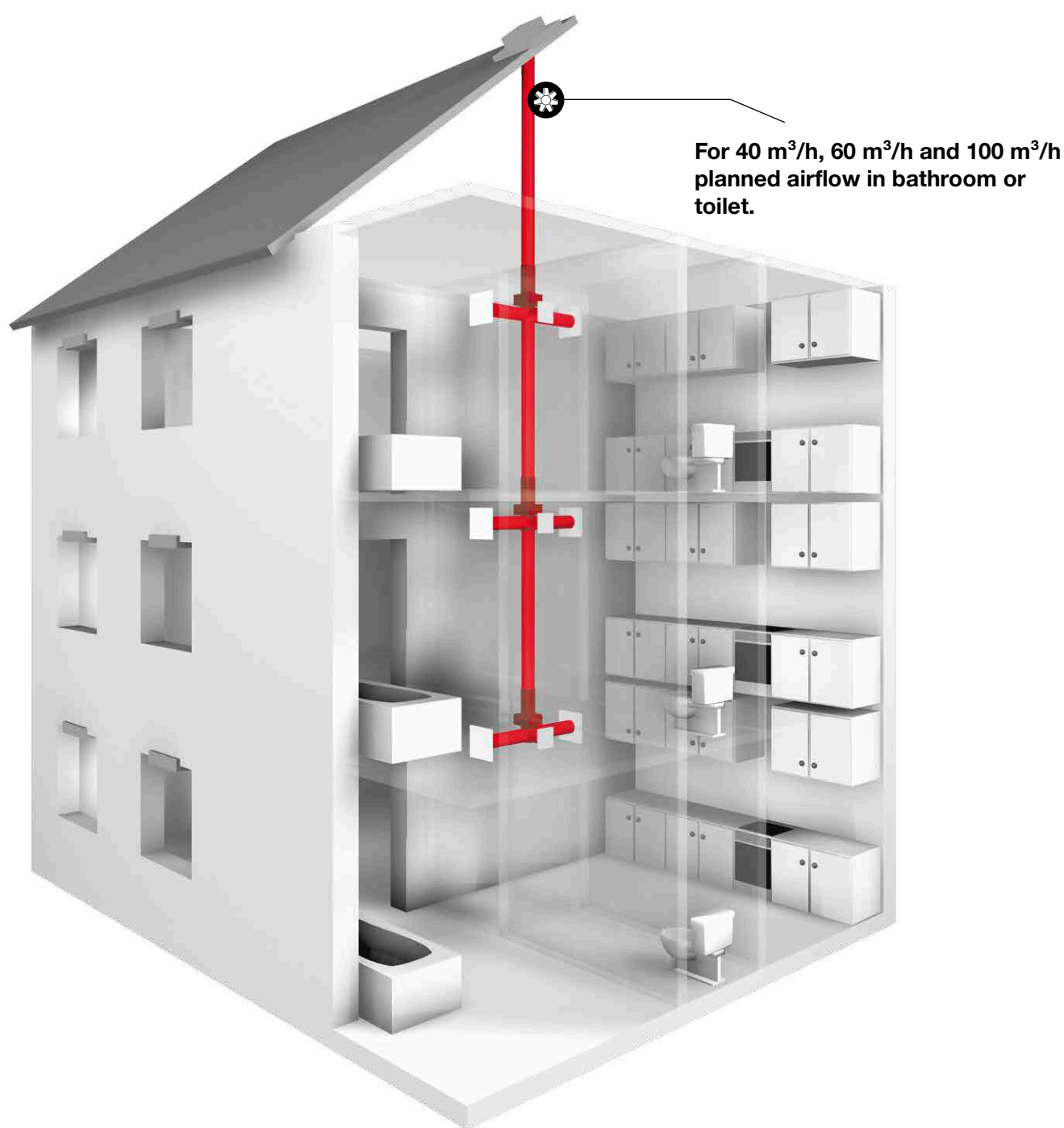

## 40 m<sup>3</sup>/h Bathroom or WC

With 40 m<sup>3</sup>/h planned flow rate and simultaneous operation of all units.

### A up to 5 m/s

One unit per floor	Two units per floor
Number of floors	Number of floors
40	24
38	19
31	15
24	12
19	9
15	7
12	6
9	5
7	4
6	3
3	1

Riser pipe diameter

### B up to 7 m/s

One unit per floor	Two units per floor
Number of floors	Number of floors
—	33
—	26
40	21
32	17
27	13
21	10
17	8
14	7
10	5
8	4
5	2

Riser pipe diameter

### C up to 11 m/s

One unit per floor	Two units per floor
Number of floors	Number of floors
—	40
—	32
—	26
40	21
33	17
27	13
21	10
16	8
13	6
8	4

Riser pipe diameter

#### A Increased comfort zone up to 5 m/s in riser pipe

with simultaneous operation of all units. The increase in noise level due to the constant flow rate control is very low up to this operating point.

#### B Comfort zone up to 7 m/s in riser pipe

with simultaneous operation of all units. The increase in noise level due to the constant flow rate control is in the comfort zone up to this operating point.

#### C Max. permitted design pressure up to 11 m/s in riser pipe

with simultaneous operation of all units. The main line dimensioning pursuant to building approval is allowed up to this operating point.

**Note:** Building law examination and compliance with building law requirements required.

If additional pipe components or roof penetrations are used, there may be deviations from the number of floors shown.

## 60 m<sup>3</sup>/h Bathroom or WC

With 60 m<sup>3</sup>/h planned flow rate and simultaneous operation of all units.

### A up to 5 m/s

One unit per floor	Two units per floor
Number of floors	Number of floors
31	15
25	12
20	10
16	8
13	6
10	5
8	4
6	3
5	2
4	2
1	1

Riser pipe diameter

### B up to 7 m/s

One unit per floor	Two units per floor
Number of floors	Number of floors
40	21
34	17
27	14
22	11
18	9
14	7
11	5
9	4
7	3
5	2
3	1

Riser pipe diameter

### C up to 11 m/s

One unit per floor	Two units per floor
Number of floors	Number of floors
—	34
—	27
40	22
35	17
27	14
21	11
18	9
14	7
11	6
9	4
5	3

Riser pipe diameter

#### A Increased comfort zone up to 5 m/s in riser pipe

with simultaneous operation of all units. The increase in noise level due to the constant flow rate control is very low up to this operating point.

#### B Comfort zone up to 7 m/s in riser pipe

with simultaneous operation of all units. The increase in noise level due to the constant flow rate control is in the comfort zone up to this operating point.

#### C Max. permitted design pressure up to 11 m/s in riser pipe

with simultaneous operation of all units. The main line dimensioning pursuant to building approval is allowed up to this operating point.

**Note:** Building law examination and compliance with building law requirements required. If additional pipe components or roof penetrations are used, there may be deviations from the number of floors shown.

## 100 m<sup>3</sup>/h Bathroom or WC

With 100 m<sup>3</sup>/h planned flow rate and simultaneous operation of all units.

(Volume e.g. kitchen = 100 m<sup>3</sup>/h. With two-room ventilation via 1 unit = Bathroom 60 m<sup>3</sup>/h, WC 40 m<sup>3</sup>/h)

### A up to 5 m/s

One unit per floor	Two units per floor
Number of floors	Number of floors
18	9
15	7
11	6
9	4
7	3
6	3
5	2
3	2
3	2
2	1
1	1

Riser pipe diameter

### B up to 7 m/s

One unit per floor	Two units per floor
Number of floors	Number of floors
25	12
20	10
16	8
13	6
10	5
8	4
6	3
5	2
4	2
3	1
2	1

Riser pipe diameter

### C up to 11 m/s

One unit per floor	Two units per floor
Number of floors	Number of floors
29	17
24	14
20	11
16	9
13	8
10	6
8	5
6	4
5	3
4	2
2	1

Riser pipe diameter

#### A Increased comfort zone up to 5 m/s in riser pipe

with simultaneous operation of all units. The increase in noise level due to the constant flow rate control is very low up to this operating point.

#### B Comfort zone up to 7 m/s in riser pipe

with simultaneous operation of all units. The increase in noise level due to the constant flow rate control is in the comfort zone up to this operating point.

#### C Max. permitted design pressure up to 11 m/s in riser pipe

with simultaneous operation of all units. The main line dimensioning pursuant to building approval is allowed up to this operating point.

**Note:** Building law examination and compliance with building law requirements required.

If additional pipe components or roof penetrations are used, there may be deviations from the number of floors shown.

# The Types.

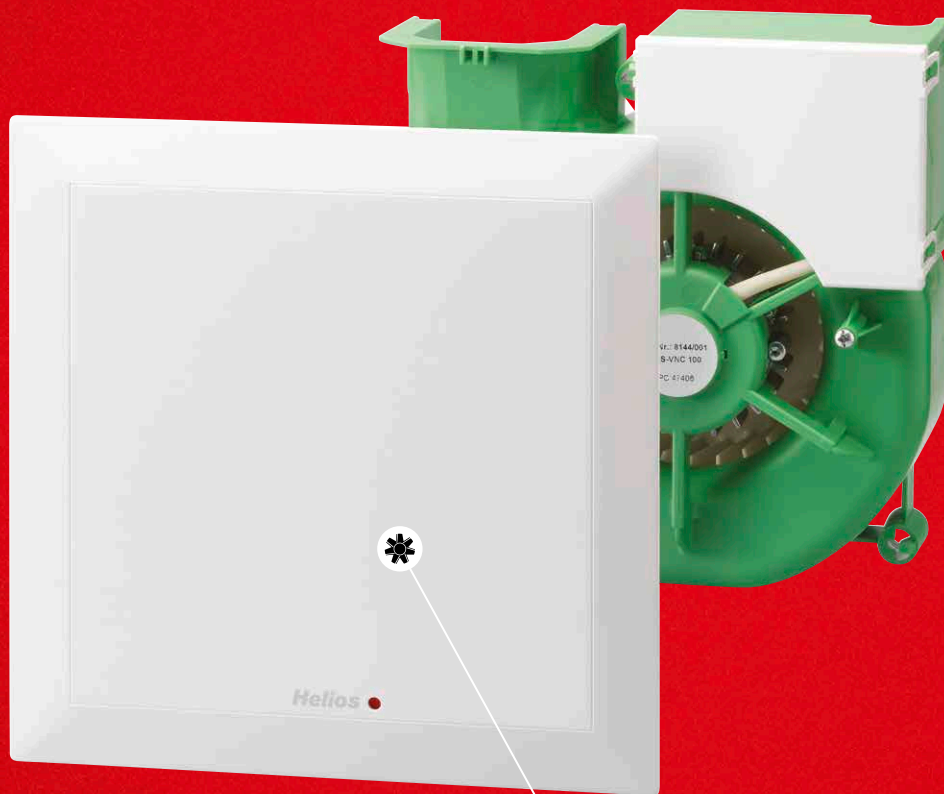

100 % Individual  
and available to precisely  
meet your requirements.

**ELS ventilation units are available in more than 60 variants** for the ventilation of bathrooms, WCs and domestic kitchens. All users will always find the ideal solution with certainty thanks to the variety of different types.



## ELS standard.

ultraSilence® ELS is the perfect solution for the **extract ventilation of inset bathrooms and WCs** in residential units, hotels or other buildings stipulated by DIN 18017-3. The standard type is available in various flow rate designs – also available with energy-saving EC technology.



## ELS with overrun (adjustable).

ELS with overrun (Type ..N) is the **ideal solution for bathrooms and WCs in residential units with normal frequency of use**. With regard to rooms with periodically low usage, ELS with adjustable overrun and interval operation (Type ..NC) offers **economical and yet safe room ventilation** – even in the absence of people. Musty rooms and moisture damage are thereby automatically and effectively prevented.



## ELS with automatic humidity control.

ELS with automatic humidity control is equipped with a **particularly effective and sophisticated system for early moisture detection**. In this respect, intelligent algorithms also detect the intensity of the moisture increase and react quicker than conventional systems. The overrun time and any necessary interval operation is also controlled fully automatically.



## ELS with motion sensor.

ELS with motion sensor is the comfortable option to set the ventilation mode depending on the frequentation of the room. Needs-based and standard-compliant ventilation is always ensured and fully automatic. **Ideal for barrier-free toilets and sanitary facilities** with private and commercial use, such as in hotels, restaurants, offices, residential homes, etc.

### **i** The following applies for all types:

Delivered ready for use with flat inner facade (alpine white) and ultraSilence® technology. Comes with permanent filter and filter cleaning indicator as standard. Integrated plug connection for electrical connection. Protective insulation, class II, IP X5. For installation in zone 1 of wetrooms. Maintenance-free, ball bearing mounted energy-saving motor. Technical approval, Z-51.1-193.



## ELS standard.

Type	Ref. no.	Area of application	Flow rate in m <sup>3</sup> /h	Power consumption in Watts	Sound pressure dB(A)*		Schalleistung L <sub>wa</sub> dB(A)		Accessories: DSEL 2 No. 01306 Speed and operating switch, 2-speed	Accessories: DSEL 3 No. 01611 Speed and operating switch, 3-speed
					Flushmount.	Surfmount	Flushmount.	Surfmount		
<b>■ ELS standard with AC technology</b> Startup delay – Overrun – *** Interval –										
<b>ELS-V 60</b>	08131	Bathroom or WC	60	18	35	39	39	43		
<b>ELS-V 60/35</b>	08133	Bathroom or WC	60/35	18/9	35/26	39/30	39/30	43/34	•	
<b>ELS-V 100</b>	08132	Bath and WC, kitchen	100	29	47	51	51	55		
<b>ELS-V 100/60/35</b>	08136	Bath and WC, kitchen	100/60/35	29/18/9	47/35/26	51/39/30	51/39/30	55/43/34	•	•
<b>■ ELS standard with EC technology</b> Startup delay – Overrun – *** Interval –										
										
<b>ELS EC 60</b>	06427	Bathroom or WC	60	6	35	39	39	43		
<b>ELS EC 60/35</b>	06428	Bathroom or WC	60/35	6/4	35/26	39/30	39/30	43/34	•	
<b>ELS EC 60/40/15</b>	06359	Bathroom or WC	60/40/15	6/5,2/3,5	35/27/21	39/31/25	39/31/25	43/35/29	•	•
<b>ELS EC 60/45/25</b>	06358	Bathroom or WC	60/45/25	6/5,4/3,7	35/28/24	39/32/28	39/32/28	43/36/32	•	•
<b>ELS EC 100</b>	06417	Bath and WC, kitchen	100	15	47	51	51	55		
<b>ELS EC 100/35</b>	06420	Bath and WC, kitchen	100/35	15/4	47/26	51/30	51/30	55/34	•	
<b>ELS EC 100/60</b>	06418	Bath and WC, kitchen	100/60	15/6	47/35	51/39	51/39	55/43	•	
<b>ELS EC 100/60/35</b>	06419	Bath and WC, kitchen	100/60/35	15/6/4	47/35/26	51/39/30	51/39/30	55/43/34	•	•



## ELS with automatic humidity control.

Type	Ref. no.	Area of application	Flow rate in m <sup>3</sup> /h	Power consumption in Watts	Sound pressure dB(A)*		Schalleistung L <sub>wa</sub> dB(A)		Accessories: DSEL 2 No. 01306 Speed and operating switch, 2-speed	Accessories: DSEL 3 No. 01611 Speed and operating switch, 3-speed
					Flushmount.	Surfmount	Flushmount.	Surfmount		
<b>■ ELS with automatic humidity control with AC technology</b> Startup delay 0/45 sec.** Overrun 6/10/15/21 min.** Interval –										
<b>ELS-VF 60</b>	08161	Bathroom or WC	60	18	35	39	39	43		
<b>ELS-VF 60/35</b>	08163	Bathroom or WC	60/35	18/9	35/26	39/30	39/30	43/34	•	
<b>ELS-VF 100/60/35</b>	08166	Bath and WC, kitchen	100/60/35	29/18/9	47/35/26	51/39/30	51/39/30	55/43/34	•	•
<b>■ ELS with automatic humidity control with EC technology</b> Startup delay 0/45 sec.** Overrun 6/10/15/21 min.** Interval –										
										
<b>ELS EC 40/15/60 F</b>	<b>NEW</b> 40170	Bathroom or WC	40/15/60	5,2/3,5/6	27/21/35	31/25/39	31/25/39	35/29/43	•	•
<b>ELS EC 40/20/60 F</b>	<b>NEW</b> 40171	Bathroom or WC	40/20/60	5,2/3,6/6	27/23/35	31/27/39	31/27/39	35/31/43	•	•
<b>ELS EC 45/25/60 F</b>	<b>NEW</b> 40172	Bathroom or WC	45/25/60	5,4/3,7/6	28/24/35	32/28/39	32/28/39	36/32/43	•	•
<b>ELS EC 60 F</b>	06408	Bathroom or WC	60	6	35	39	39	43		
<b>ELS EC 60/15 F</b>	<b>NEW</b> 40173	Bathroom or WC	60/15	6/3,5	35/21	39/25	39/25	43/29	•	
<b>ELS EC 60/35 F</b>	06409	Bathroom or WC	60/35	6/4	35/26	39/30	39/30	43/34	•	
<b>ELS EC 60/40/15 F</b>	06374	Bathroom or WC	60/40/15	6/5,2/3,5	35/27/21	39/31/25	39/31/25	43/35/29	•	•
<b>ELS EC 60/45/25 F</b>	06365	Bathroom or WC	60/45/25	6/5,4/3,7	35/28/24	39/32/28	39/32/28	43/36/32	•	•
<b>ELS EC 100 F</b>	06404	Bath and WC, kitchen	100	15	47	51	51	55		
<b>ELS EC 100/35 F</b>	06407	Bath and WC, kitchen	100/35	15/4	47/26	51/30	51/30	55/34	•	
<b>ELS EC 100/60 F</b>	06405	Bath and WC, kitchen	100/60	15/6	47/35	51/39	51/39	55/43	•	
<b>ELS EC 100/60/35 F</b>	06406	Bath and WC, kitchen	100/60/35	15/6/4	47/35/26	51/39/30	51/39/30	55/43/34	•	•

\* for AL = 10<sup>2</sup> equivalent absorption area, \*\* marked value corresponds to factory setting, \*\*\* optional overrun see Accessories, page 39





## ELS with overrun / ELS with adjustable overrun.

Type	Ref. no.	Area of application	Flow rate in m³/h	Power consumption in Watts	Sound pressure dB(A)*		Schalleistung L <sub>WA</sub> dB(A)		Accessories: DSEL 2 No. 01306 Speed and operating switch, 2-speed	Accessories: DSEL 3 No. 01611 Speed and operating switch, 3-speed
					Flushmount.	Surfmount	Flushmount.	Surfmount		
<b>■ ELS with overrun (VN) / with adjustable overrun (VNC) with AC technology</b> <b>Types VN:</b> Startup delay 45 sec. <b>Types VNC:</b> Startup delay 0/45 sec.** Overrun 6/15/21 min.**      Overrun 6/10/15/21 min.** Interval –      Interval 4/8/12/24 hrs.**										
ELS-VN 60	08137	Bathroom or WC	60	18	35	39	39	43		
ELS-VN 60/35	08139	Bathroom or WC	60/35	18/9	35/26	39/30	39/30	43/34	•	
ELS-VN 100	08138	Bath and WC, kitchen	100	29	47	51	51	55		
ELS-VN 100/60	08141	Bath and WC, kitchen	100/60	29/18	47/35	51/39	51/39	55/43	•	
ELS-VNC 60	08143	Bathroom or WC	60	18	35	39	39	43		
ELS-VNC 100	08144	Bath and WC, kitchen	100	29	47	51	51	55		
<b>■ ELS with overrun (N) / with adjustable overrun (NC) with EC technology</b> <b>Types N:</b> Startup delay 45 sec. <b>Types NC:</b> Startup delay 0/45 sec.** Overrun 15 min.      Overrun 6/10/15/21 min.** Interval –      Interval 0/8/12/24 hrs.**										
ELS EC 40/60 N <b>NEW</b>	40098	Bathroom or WC	40/60	5,2/6	27/35	31/39	31/39	34/43	•	
ELS EC 60 N	06429	Bathroom or WC	60	6	35	39	39	43		
ELS EC 60/15 N <b>NEW</b>	40099	Bathroom or WC	60/15	6/3,5	35/21	39/25	39/25	43/29	•	
ELS EC 60/35 N	06504	Bathroom or WC	60/35	6/4	35/26	39/30	39/30	43/34	•	
ELS EC 100 N	06421	Bath and WC, kitchen	100	15	47	51	51	55		
ELS EC 100/35 N	06505	Bath and WC, kitchen	100/35	15/4	47/26	51/30	51/30	55/34	•	
ELS EC 100/60 N	06498	Bath and WC, kitchen	100/60	15/6	47/35	51/39	51/39	55/43	•	
ELS EC 100/60/35 N	06430	Bath and WC, kitchen	100/60/35	15/6/4	47/35/26	51/39/30	51/39/30	55/43/34	•	•
ELS EC 40/15/60 NC <b>NEW</b>	40102	Bathroom or WC	40/15/60	5,2/3,5/6	27/21/35	31/25/39	31/25/39	35/29/43	•	•
ELS EC 45/25/60 NC <b>NEW</b>	40114	Bathroom or WC	45/25/60	5,4/3,7/6	28/24/35	32/28/39	32/28/39	36/32/43	•	•
ELS EC 60 NC	06402	Bathroom or WC	60	6	35	39	39	43		
ELS EC 60/15 NC <b>NEW</b>	40169	Bathroom or WC	60/15	6/3,5	35/21	39/25	39/25	43/29	•	
ELS EC 60/35 NC	06403	Bathroom or WC	60/35	6/4	35/26	39/30	39/30	43/34	•	
ELS EC 60/40/15 NC	06356	Bathroom or WC	60/40/15	6/5,2/3,5	35/27/21	39/31/25	39/31/25	43/35/29	•	•
ELS EC 60/45/25 NC	06355	Bathroom or WC	60/45/25	6/5,4/3,7	35/28/24	39/32/28	39/32/28	43/36/32	•	•
ELS EC 100 NC	06398	Bath and WC, kitchen	100	15	47	51	51	55		
ELS EC 100/35 NC	06401	Bath and WC, kitchen	100/35	15/4	47/26	51/30	51/30	55/34	•	
ELS EC 100/60 NC	06399	Bath and WC, kitchen	100/60	15/6	47/35	51/39	51/39	55/43	•	
ELS EC 100/60/35 NC	06400	Bath and WC, kitchen	100/60/35	15/6/4	47/35/26	51/39/30	51/39/30	55/43/34	•	•



## ELS with motion sensor.

Type	Ref. no.	Area of application	Flow rate in m³/h	Power consumption in Watts	Sound pressure dB(A)*		Schalleistung L <sub>WA</sub> dB(A)		Accessories: DSEL 2 No. 01306 Speed and operating switch, 2-speed	Accessories: DSEL 3 No. 01611 Speed and operating switch, 3-speed
					Flushmount.	Surfmount	Flushmount.	Surfmount		
<b>■ ELS with motion sensor with AC technology</b> Startup delay – Overrun 15 min. Interval –										
ELS-VP 60	08149	Bathroom or WC	60	18	35	39	39	43		
ELS-VP 100	08150	Bath and WC, kitchen	100	29	47	51	51	55		
<b>■ ELS with motion sensor with EC technology</b> Startup delay 0/45 sec.** Overrun 6/10/15/21 min.** Interval 0/8/12/24 hrs.**										
ELS EC 40/15/60 P <b>NEW</b>	40174	Bathroom or WC	40/15/60	5,2/3,5/6	27/21/35	31/25/39	31/25/39	35/29/43	•	•
ELS EC 45/25/60 P <b>NEW</b>	40175	Bathroom or WC	45/25/60	5,4/3,7/6	28/24/35	32/28/39	32/28/39	36/32/43	•	•
ELS EC 60 P	06415	Bathroom or WC	60	6	35	39	39	43		
ELS EC 60/35 P	06416	Bathroom or WC	60/35	6/4	35/26	39/30	39/30	43/34	•	
ELS EC 100 P	06410	Bath and WC, kitchen	100	15	47	51	51	55		
ELS EC 100/35 P	06414	Bath and WC, kitchen	100/35	15/4	47/26	51/30	51/30	55/34	•	
ELS EC 100/60 P	06412	Bath and WC, kitchen	100/60	15/6	47/35	51/39	51/39	55/43	•	
ELS EC 100/60/35 P	06413	Bath and WC, kitchen	100/60/35	15/6/4	47/35/26	51/39/30	51/39/30	55/43/34	•	•

\* for AL = 10° equivalent absorption area, \*\* marked value corresponds to factory setting

# The Casings.

One casing.  
All possibilities.



The flush-mounted casing ELS-GU is not only delightfully compact, but also almost infinitely flexible in application. Whether it is used for single room and two room ventilation or WC connection via the flush pipe – ELS-GU fits optimally in all situations.

Installation is possible in walls, shafts, plasterboards or ceilings, whereby the discharge spigots can be optionally positioned to the back or top. Furthermore, the casing can be rotated by 90° to the left or right. Simple and without tools.

There is just one casing type for each type of installation and all ventilation requirements, which is not only practical on the construction site, but also extremely economical for storage.

ELS-GUBA, the clever flush-mounted casing with integrated fire protection damper, also offers the same advantages.

### 1 Single room ventilation

Intake via front facade.

### 2 Two room ventilation

Two room ventilation with discharge to top or back.

### 3 WC connection

WC seat connection via flush pipe, discharge to top or back.

The flush-mounted casings from ultraSilence® ELS are just as smart. ELS-GAP and ELS-GAPB with the fire protection damper can be mounted by turning the discharge spigots by 360°, so that the air outlet can be positioned to the top left or right and bottom left or right.

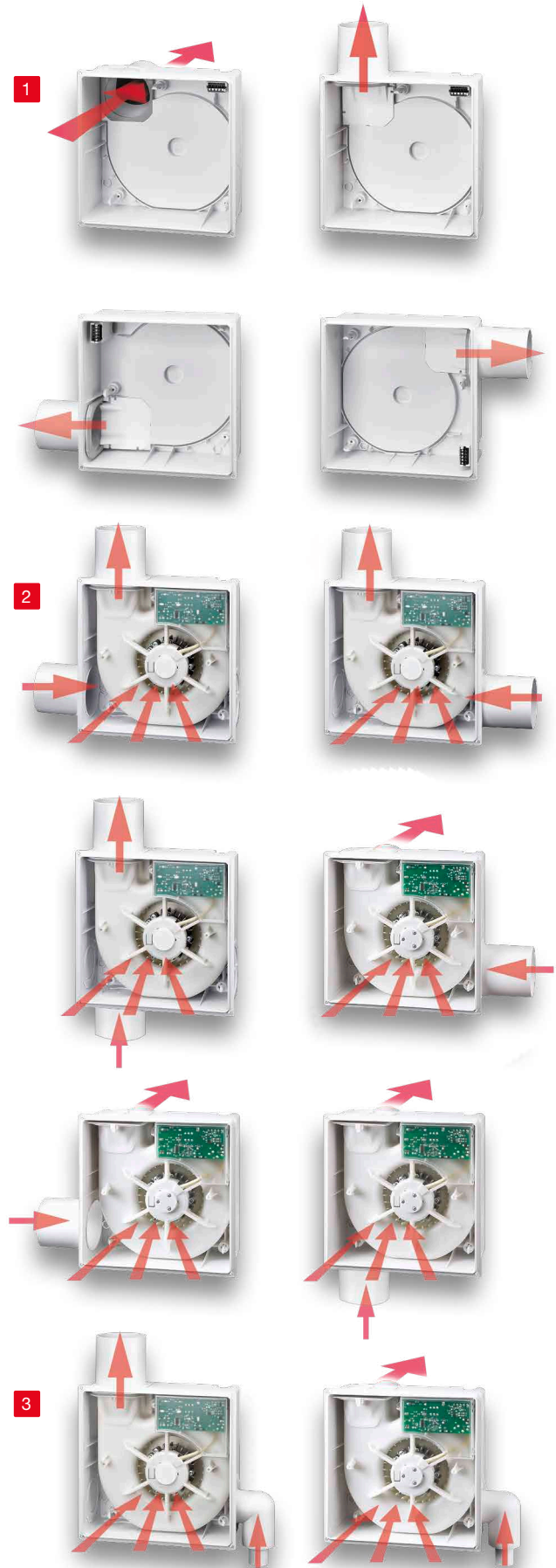

# The perfect casing solution for all requirements.

Adapted to the installation location and fire protection requirements, the perfect casing solution is always at the ready. Determine the applicable installation situation using the illustrations and select the corresponding casing in the quick overview. All relevant casing details can be found on the following pages.

- A** Inside K90 shaft
- B** Outside K90 shaft
- C** On K90 shaft
- D** With fire damper
- E** Without fire protection

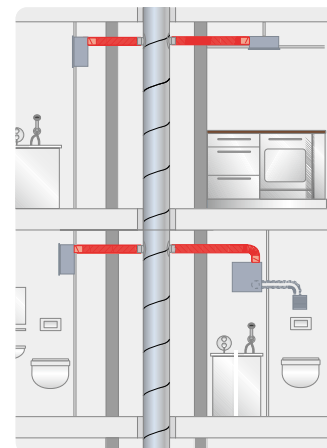
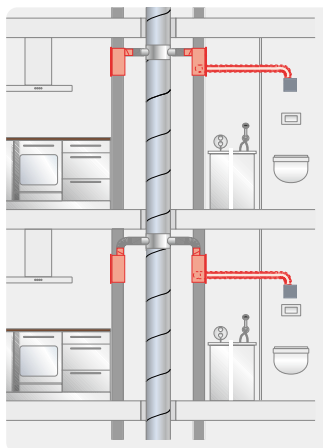
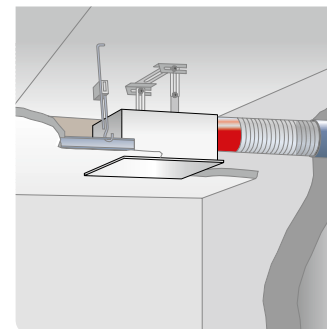
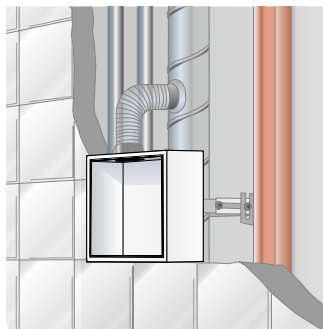

**A** Inside K90 shaft

Steel flexpipe connection only to second room connection.

**B** Outside K90 shaft

Steel flexpipe connection to main line.

## Quick selection

Installation, discharge	Type	Ref. no.	Type	Ref. no.
<b>Single room ventilation of bathroom, WC or domestic kitchen</b>				
Flush-mounted, lateral discharge	ELS-GUB	08112	ELS-GUBA	08114
Flush-mounted, discharge to back	ELS-GUBR	08113	ELS-GUBA + access. ELS-ARS	08114 08185
Surface-mounted, discharge to back			ELS-GAPB	08128
Surface-mounted, lateral discharge			ELS-GUBA + access. ELS-APASA	08114 07328
<b>Two room ventilation of bathroom and WC</b>				
Flush-mounted, lateral discharge	ELS-GUBZL left ELS-GUBZR right	08115 08117	ELS-GUBA ELS-ZS	08114 08186
Flush-mounted, discharge to back	ELS-GUBRZL left ELS-GUBRZR right	08116 08118	ELS-GUBA + access. ELS-ARS + access. ELS-ZS	08114 08185 08186

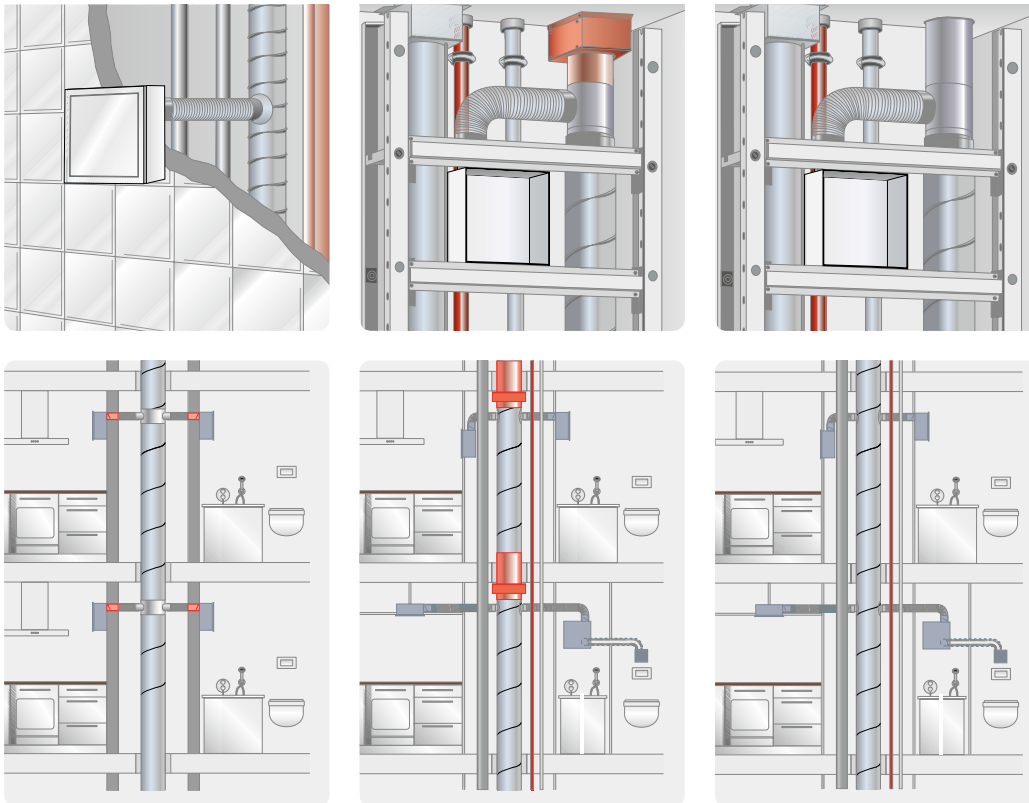

### Information on fire protection in multi-storey buildings

With regard to the planning and execution of ventilation systems, the State fire protection requirements must be complied with.

Buildings with more than two full floors are normally subject to such requirements.

In order to prevent the transmission of fire to other fire sections, the illustrated solutions are available according to the structural conditions for the installation of mono tube ventilation systems.

**C** On K90 shaft

**D** With fire damper

**E** Without fire protection

For up to 2 full floors.

Type	Ref. no.	Type	Ref. no.	Type	Ref. no.	Installation, discharge
		ELS-GU	08111	ELS-GU	08111	Flush-mount., lateral discharge
		ELS-GU + access. ELS-ARS	08111 08185	ELS-GU + access. ELS-ARS	08111 08185	Flush-moun., discharge to back
ELS-GAPB	08128	ELS-GAP	08127	ELS-GAP	08127	Surface-mou., disch. to back
ELS-GAPB	08128	ELS-GU + access. ELS-APASA	08111 07328	ELS-GU + access. ELS-APASA	08111 07328	Surface-mou., lat. disch.
		ELS-GU + access. ELS-ZS	08111 08183	ELS-GU + access. ELS-ZS	08111 08186	Flush-mount., lateral discharge
		ELS-GU + access. ELS-ARS + access. ELS-ZS	08111 08185 08186	ELS-GU + access. ELS-ARS + access. ELS-ZS	08111 08185 08186	Flush-moun., discharge to back

**A Flush-mounted installations in wall, ceiling and fire-resistant shaft (F90) or L90 ventilation ducts.**

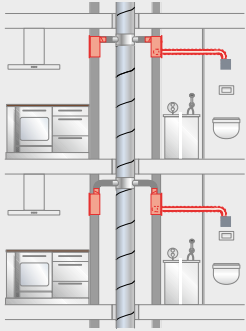

Connection of up to 3 casings per floor possible on more than 20 full floors. The second room connection must be carried out with steel flexpipe connection.

- Flush-mounted casing with fire protection encasement K90
- Metal discharge spigot with automatic backdraught shutter and shut-off upon triggering of fusible link

- Removable plug connector for electrical connection
- Replaceable hinged plaster cover
- Connection DN 80 mm
- General technical approval, Z-51.1-193

■ Single room ventilation of bathroom, WC or domestic kitchen

		<b>Type</b>	<b>ELS-GUB</b>
		Ref. no.	08112
		Installation	Flush-mounted
		Discharge	lateral, upward, can be turned to left or right
		<b>Type</b>	<b>ELS-GUBR</b>
		Ref. no.	08113
		Installation	Flush-mounted
		Discharge	to the back, rotatable by 90° in any direction

■ Ventilation of bathroom and WC

		<b>Type</b>	<b>ELS-GUBZL</b>
		Ref. no.	08115
		Installation	Flush-mounted
		Discharge	lateral, upward, can be rotated left or right
		Sec. room connection	Left
		<b>Type</b>	<b>ELS-GUBZR</b>
		Ref. no.	08117
		Installation	Flush-mounted
		Discharge	lateral, upward, can be rotated left or right
		Sec. room connection	Right
		<b>Type</b>	<b>ELS-GUBRZL</b>
		Ref. no.	08116
		Installation	Flush-mounted
		Discharge	to the back, rotatable by 90° in any direction
		Sec. room connection	Left

■ Zweiraum-Lüftung von Bad oder WC

		<b>Type</b>	<b>ELS-GUBRZR</b>
		Ref. no.	08118
		Installation	Flush-mounted
		Discharge	to the back, rotatable by 90° in any direction
		Sec. room connection	Right

**B** Flush or surface-mounted installations in wall or ceiling outside of fire-resistant shafts (F90) or L90 ventilation ducts.

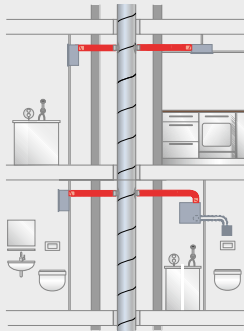

Connection of up to 3 casings per floor possible on more than 20 floors. Steel flexpipe connection to main line.

- Removable plug connector for electrical connection
- Connection DN 80 mm
- General technical approval, Z-51.1-193

- Plastic casing with fire protection element K90
- Metal discharge spigot with automatic backdraught shutter and shut-off upon triggering of fusible link
- Made of plastic (white), in fire class B 2

■ Single room ventilation of bathroom, WC or domestic kitchen

Also for second room ventilation of bathroom and WC by means of accessory set\*

			<b>Type</b>	<b>ELS-GUBA</b>
			Ref. no.	08114
			Installation	Flush-mounted
			Discharge	lateral, upward, can be turned to left or right
			Optional discharge	to the back, rotatable by 90° in any direction ELS-ARS, Ref. no. 08185
*Sec. room ventilation optionally left or right		by means of ELS-ZS, Ref no. 08186		
		<b>Type</b>	<b>ELS-APASA (+ ELS-GUBA)**</b>	
		Ref. no.	07328	
		Installation	Surface-mounted	
		Discharge	lateral, upward, can be turned to left or right	
		**ELS-GUBA (Ref. no. 08114) is not included in the scope of delivery.		
		<b>Type</b>	<b>ELS-GAPB</b>	
		Ref. no.	08128	
		Installation	Surface-mounted	
		Discharge	to the back, rotatable by 90° in any direction	

**C Surface-mounted installation in wall or ceiling on walls of fire-resistant shafts (F90) or ventilation ducts (L90).**

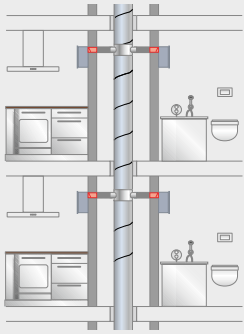

Connection of up to 3 casings per floor possible on more than 20 floors.

- Surface mounting casing with fire protection element K90
- Metal discharge spigot with automatic backdraught shutter and shut-off upon triggering of fusible link
- Removable plug connector for electrical connection

- Made of plastic (white), in fire class B 2
- Connection Ø air outlet DN 80 mm
- General technical approval, Z-51.1-193

■ Single room ventilation of bathroom, WC or domestic kitchen

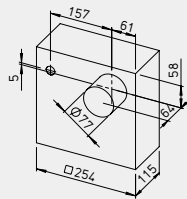

Type	ELS-GAPB
Ref. no.	08128
Installation	Surface-mounted
Discharge	to the back, rotatable by 90° in any direction

**D Flush or surface-mounted installation in wall, ceiling or in installation shaft with fire protection solution ELS-D fire damper.**

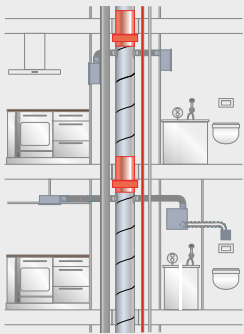

Connection of up to 3 casings per floor possible. For more than 20 floors when using fire protection damper in the main line

- Applicable casings: Universal casing without fire protection ELS-GU for flush-mounting, or ELS-GAP or ELS-APASA in connection with ELS-GU for surface-mounting

- Casing without fire protection, with airtight backdraught shutter
- Removable plug connector for electrical connection
- Made of plastic (white), in fire class B 2
- Connection DN 80 mm
- General technical approval, Z-51.1-193

■ Flush or surface-mounted installation. Single room ventilation of bathroom, WC or domestic kitchen.

Also for second room ventilation of bathroom and WC by means of accessory set\*

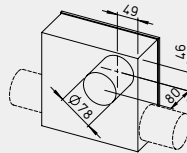
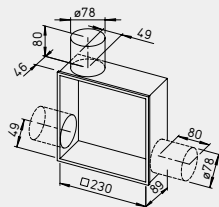

Type	ELS-GU
Ref. no.	08111
Installation	Flush-mounted
Discharge	lateral, upward, left or right
Optional discharge	to the back, rotatable by 90° in any direction using ELS-ARS Ref. no. 08185 by
*Sec. room ventilation optionally left or right	means of ELS-ZS, Ref. no. 08186

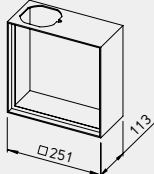

Type	ELS-APASA (+ ELS-GU)**
Ref. no.	07328
Installation	Surface-mounted
Discharge	lateral, upward, can be rotated left or right

\*\*ELS-GU (Ref. no. 08111) is not included in scope of delivery.

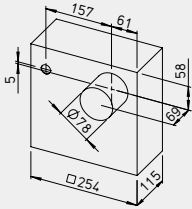

■ Surface-mounting. Single room ventilation of bathroom, WC or domestic kitchen.

		<b>Type</b>	<b>ELS-GAP</b>
		Ref. no.	08127
		Installation	Surface-mounted
		Discharge	to the back, rotatable by 90° in any direction

**E** Flush or surface-mounted installations in wall, ceiling or in installation shaft without fire protection.

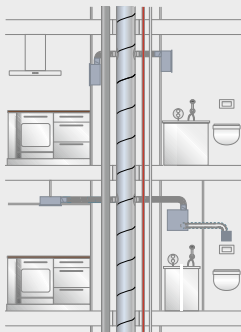

Connection of up to 3 casings per floor possible. For connection to shared main line of up to two full floors.

- Applicable casings: Universal casing without fire protection ELS-GU for flush-mounting, or ELS-GAP or ELS-APASA in connection with ELS-GU for surface-mounting.



- Casing without fire protection, with airtight backdraught shutter
- Removable plug connector for electrical connection
- Made of plastic (white), in fire class B 2
- Connection DN 80 mm.
- General technical approval, Z-51.1-193

■ Flush-mounting. Single room ventilation of bathroom, WC or domestic kitchen.

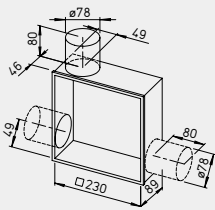
Also for second room ventilation of bathroom and WC by means of accessory set\*

		<b>Type</b>	<b>ELS-GU</b>
		Ref. no.	08111
		Installation	Flush-mounted
		Discharge	lateral, upward, left or right
Optional discharge	to the back, rotatable by 90° in any direction ELS-ARS Ref. no. 08185		
*Sec. room ventilation optionally left or right	by means of ELS-ZS, Ref. no. 08186		

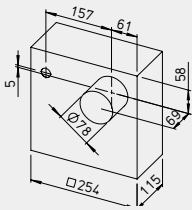
■ Surface-mounting. Single room ventilation of bathroom, WC or domestic kitchen.

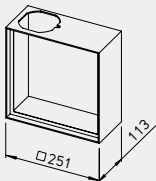
		<b>Type</b>	<b>ELS-GAP</b>
		Ref. no.	08217
		Installation	Surface-mounted
		Discharge	to the back, rotatable by 90° in any direction
		<b>Type</b>	<b>ELS-APASA (+ ELS-GU)**</b>
		Ref. no.	07328
		Installation	Surface-mounted
		Discharge	lateral, upward, can be turned to left or right
		**ELS-GU (Ref. no. 08111) is not included in scope of delivery.	

# As clever as the entire system: The installation.

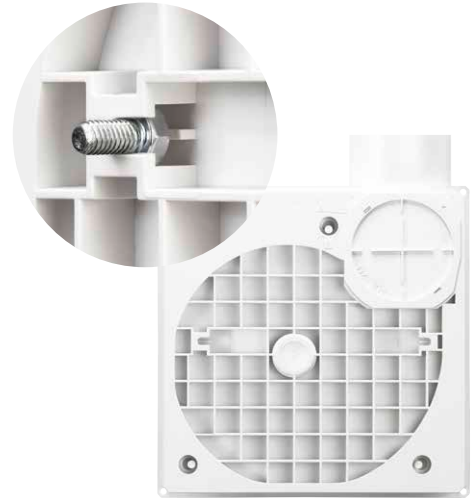
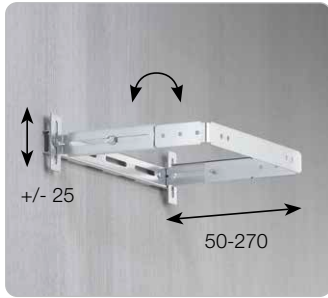

## ■ ELS-MB

The mounting bracket ELS-MB provides the ideal connection between ELS and the system elements from the plasterboard supplier for integration in plasterboard systems. ELS-MB is easily mounted to the back of the ELS casing using hexagon-head and square-head screws in the rotation-proof grooves.

## ■ ELS-MHU

With regard to installation in shafts and suspended ceilings, the universal mounting bracket ELS-MHU provides the necessary flexibility. Practical for flush-mounted casing installation in installation shafts, primarily for casings with fire protection encasement. For mounting the casing to the ceiling or wall.

## ■ Clever plug-in fixing for mounting screws to ELS-MB and ELS-MHU.

All flush-mounted casings can be correctly positioned in a few minutes as it is adjustable in height, depth and perpendicular. Rotation-proof grooves for hexagon-head or square-head screws are recessed on the back of casing types ELS-GU and -GUBA. They form the fixing points for the mounting bracket; alternatively, there are two predetermined breaking points for firm screwing to on-site elements.

### Swiftly into the plasterboard.

Adapted to construction progress: Installation in common plasterboard systems becomes a real pleasure thanks to the refined installation features and the clever plasterboard adapter ELS-VA.

All in one step: The complete installation of ultraSilence® ELS can also take place as part of the final installation upon request. The entire installation is completed in a few simple steps.



**1** Extract air duct and mains connection are placed at the subsequent ELS installation position.



**1** Extract air duct and mains connection are placed at the subsequent ELS installation position.



**2** Markings on the ELS casing make it easy to carry out the plasterboard cut-out quickly and with the highest precision.



**2** The corresponding plasterboard cut-out is created for the installation preparation.



**3** The practical plasterboard adapter ELS-VA is now mounted. Extract air duct and mains connection are connected to the ELS casing. The casing is then simply inserted. Practical: the supplied plaster cover protects against contamination.



**3** The desired final wall covering is applied.



**4** The desired final wall covering is applied.



**4** The flush-mounted casing can now be very simply connected to the mains line with the pre-mounted plasterboard adapter and fan. It is then inserted into the finished wall.



**5** The fan is simply inserted – and audibly clicks in as part of the final work in the room.



**5** The plasterboard adapter is then directly screwed to the wall – and this ensures the highest stability.



**6** The facade panel is mounted and the standard permanent filter is inserted in a few simple steps.



**6** The facade panel is then mounted using the spacer frame ELS-AGR and the permanent filter is inserted.



**7** ultraSilence® ELS is now operational.



**7** ultraSilence® ELS is now operational.

# The Accessories.

1

ELS accessories for casings and fans



2

Electrical accessories



3

Inflow elements and air grilles



**Adaption kit for discharge to the back**

**ELS-ARS** Ref. no. 08185  
The air discharge spigot can be placed on the back of the unit for the flush-mounted casings ELS-GU and -GUBA without fire protection encasement. The ARS diverter must simply be mounted on the discharge side in the fan for the correct air flow.



**Plasterboard adapter**

**ELS-VA** Ref. no. 08189  
Allows the front-side insertion and mounting of flush-mounted ELS casings in plasterboard. The adapter is screwed to the casing and its frame with Spax screws or plasterboard screws.

**Second room kit**

**ELS-ZS** Ref. no. 08186  
Extract air unit for flush-mounted installation for connection to all casings for second room connection ELS-GU. Award-winning design facade in alpine white, with closed front and all-round air inflow. Integrated, easily accessible air filter. Includes second room connection spigots for fan casings ELS-GU and -GUBA.



**WC connection kit**

**ELS-WCS** Ref. no. 08191  
Kit for connecting WC extraction in combination with the room ventilation; for casing types ELS-GU, -GUBA. The fan casing and cistern pipe are connected with commercially available HT pipes. Scope of delivery: Connecting panel, 90° angle, 2 stepped spigots Ø 40 and 30 mm.



**Second room connection spigots**

**ELS-ZAS** Ref. no. 08184  
Spigots for casing types ELS-GU and -GUBA. For the connection of second room extraction on site. NW 75/80 mm.



**Universal mounting bracket**

**ELS-MHU** Ref. no. 08187  
Practical for flush-mounted casing installation in installation shafts, primarily for casings with fire protection encasement. For mounting the casing to the ceiling or wall. Adjustable in height, depth and perpendicular; fits with all flush-mounted casing types.

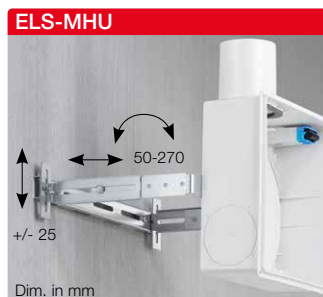

**Mounting bracket**

**ELS-MB** Ref. no. 08188  
For mounting flush-mounted casings in plasterboard systems in connection with elements from the plasterboard supplier. The mounting bracket is easily mounted to the back of the ELS casing using hexagon-head and square-head screws in the rotation-proof grooves.



**Surface-mounted adapter with side discharge**

**ELS-APASA** Ref. no. 07328  
Made of steel sheet in alpine white. Insulated adapter with side discharge for surface-mounted installation. Suitable for casing types ELS-GU and ELS-GUBA.

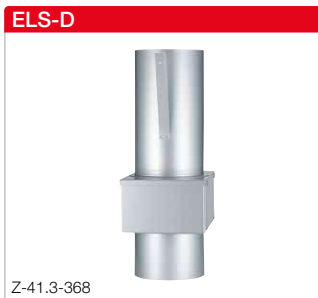

**Fire damper**

When using this shut-off damper, all other components do not require any fire resistance classification. The universally applicable casing types ELS-GU (UP) and -GAP (AP) can be connected. The stub and connection lines are cost-effective and installation-friendly in Aluflex pipe.

**Sunken frame**

**ELS-VSR** Ref. no. 07322  
Made of steel sheet in alpine white. Allows flush-mounted wall and ceiling installation of inner facade. Suitable for ELS-GU and ELS-GUBA.

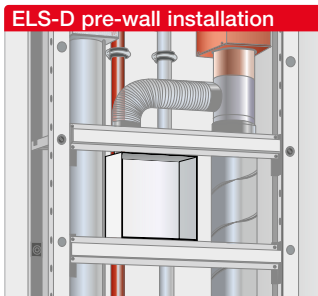

Type	Ref. no.	Main line
ELS-D 100	00270	100 mm
ELS-D 125	00185	125 mm
ELS-D 140	00186	140 mm
ELS-D 160	00187	160 mm
ELS-D 180	00188	180 mm
ELS-D 200	00271	200 mm

**Flush-mounted spacer frame**

**ELS-UPA** Ref. no. 07332  
Used when ELS-GU and ELS-GUBA are installed too deep. This closes the gap (max. 50 mm) between the casing and panelling.

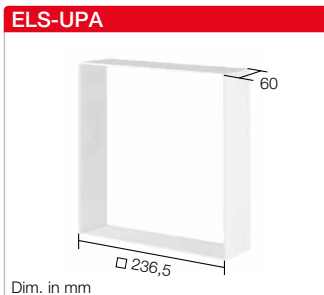

**Spacer frame**

**ELS-AGR** Ref. no. 08193  
Covers up to 15 mm of protruding flush-mounted casing, which has not been installed flush with the plaster or tiles. The spacer frame is simply fixed between the wall/ceiling and ELS inner facade.



**Plasterboard cover**

**ELS-PB** Ref. no. 08194  
For covering gaps in case of casing cut-outs which have been unclearly plastered, tiled or if they are too large, which cannot be completely covered by the ELS inner facade. The plaster cover is simply fixed between the wall/ceiling and ELS inner facade.

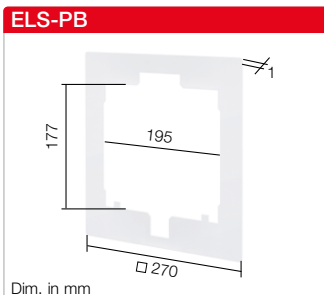

**Speed and operating switch**
**DSEL 2** Ref. no. 01306

Fan: see pages 24–25

Reversing or speed and on/off rocker switch, can be used to change the speed of fans with two performance levels. Front made of white plastic. For installation in 55 flush-mounted box. Protection type IP 30, 230 V, 50/60 Hz, I max. 3 A inductive.

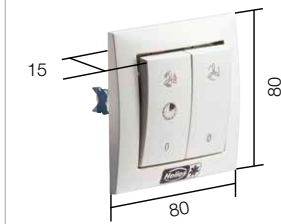
**DSEL 2**

Dim. in mm

**ZNE**

**Overrun timer**
**ZNE** Ref. no. 00342

Ventilatoreins.: ELS-V 60, ELS-V 100. With continuously variable overrun times from 0 to 21 min. Startup delay (45 sec.), optional activation. Activation via on/off switch, e.g. together with light. Miniature construction with minimum dimensions. For installation in flush-mounted box behind switch. 230 V, I max. 0.8 A (ind.), I min. 0.05 A. IP 40.

**Speed and operating switch**
**DSEL 3** Ref. no. 01611

Fan: see pages 24–25

Rotary switch with 0 position for controlling fans with 3 speeds. Room light cannot be switch in parallel. Front made of white plastic. For installation in 55 flush-mounted box. Protection type IP30, 230 V, 50/60 Hz, I max., 3 A inductive.

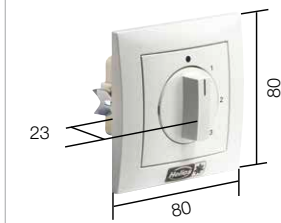
**DSEL 3**

Dim. in mm

**ZNI**

**Overrun timer**
**ZNI** Ref. no. 00343

Ventilatoreins.: ELS-V 60, ELS-V 100. Automatic ventilation in adjustable time intervals (4, 8, 12 or 24 hrs.), provided there is no manual activation within the time phase. In case of manual activation (e.g. activation via light switch), there will be an overrun between 0 and 21 minutes, continuously variable. For installation in flush-mounted box behind switch. 230 V, I min. 0.05 A, I max 0.8 A (ind.). IP 40.

**Electronic overrun timer**
**ZV** Ref. no. 01279

Fan: ELS V.. and ELS EC

Overrun timer with continuously variable times and permanent mode setting. Parallel switching of light and fan possible via on/off switch or button. Protection type IP 30, 230 V, 50/60 Hz, I max. 2.1 A (ind.) DIN rail mounting in distribution box.

**ZV**

## ZLA 125



## Supply air unit ZLA 125

	Type	Ref. no.
Inner panel 22 m <sup>3</sup> /h	ZLA 125 IB 22	04393
Inner panel 30 m <sup>3</sup> /h	ZLA 125 IB 30	04394
Inner panel humidity-controlled	ZLA 125 IB HY 6-45	04395
Installation kit	ZLA 125 RS	04396
Sound insulating element	ZLA 125 SE	04397
Facade panel	ZLA 125 FB	04398
Spare air filter	ELF-DLV	03058

Further information can be found on pages 42/43.

## ZLA



## Outside air inflow element – Installation in wall openings

## Outside air inflow elements – Installation in wall openings

Type	Ref. no.	Supply air unit Ø
ZLA 80	00214	Ø 80
ZLA 100	00215	Ø 100
ZLA 160	00216	Ø 160

Automatically temperature-controlled including thermostat supply valve, sound insulation and external grille. Further information can be found at [www.HeliosSelect.de](http://www.HeliosSelect.de).

## ZLE



## Outside air inflow element – Installation in wall openings

## Supply air unit Ø 100

**ZLE 100** Ref. no. 00079

Manual controllable in four stages including supply valve with draw-cord, sound insulation and external grille. Further information can be found at [www.HeliosSelect.de](http://www.HeliosSelect.de).



**Outside air inflow elements –  
Installation in window frames**
**Outside air inflow element**
**30 m<sup>3</sup>/h**
**ALEF 30** Ref. no. 02100

**Outside air inflow element**
**45 m<sup>3</sup>/h**
**ALEF 45** Ref. no. 02101

With flow rate control and limiter.

**ALEF 30 / ALEF 45**

**ALEFS 30 / ALEFS 45**

**Outside air inflow elements –  
Installation in window frames**
**Outside air inflow element**
**30 m<sup>3</sup>/h**
**ALEFS 30** Ref. no. 02102

**45 m<sup>3</sup>/h**
**ALEFS 45** Ref. no. 02103

With flow rate control and limiter.

With integrated sound insulation.

**Outside air inflow element**
**5/45 m<sup>3</sup>/h**
**ALEF 5/45 Hygro** No. 02056

Humidity-controlled, with flow rate control and limiter.

**ALEF 5/45 Hygro**

**ALEFS 5/45 Hygro**

**Outside air inflow element**
**5/45 m<sup>3</sup>/h**
**ALEFS 5/45 Hygro** No. 02057

Humidity-controlled, with flow rate control and limiter. With integrated sound insulation.

**Overflow**
**Door ventilation grille white**
**LTGW** Ref. no. 00246

**Door ventilation grille brown**
**LTGB** Ref. no. 00247

Discreet, sight-screening ventilation grille made of durable plastic for installation in indoor panel.

**LTGW / LTGB**

**Spare air filter made of renewable synthetic fibre, class Iso Coarse 30%**
**ELF-ELS** Ref. no. 08190

Permanent filter for ELS-V fans, suitable for cleaning in dishwasher, packaging unit = 2 pcs.

**ELF-ZS** Ref. no. 00557

For second room intake unit ELS-ZS, packaging unit = 5 pcs.

**ELF-ELS / ELF-ZS**

**Thermostat supply valve**

Type	Ref. no.	Ø
ZTV 80	00078	Ø 80
ZTV 100	00073	Ø 100
ZTV 160	00074	Ø 160

For installation in existing ventilation openings.

**ZTV**

# The new supply air unit ZLA 125: With a standard sound level difference of up to 51 dB.



External view

## Always fits perfectly

The new supply air units ZLA from Helios easily provide fresh air – fully automatically. With these universally usable automatic units, the supply air flowing inside is perfectly distributed, filtered (class Iso Coarse 30%) and optimally sound-insulated. The ZLA 125 consists of an inner panel, installation kit and facade panel, it fits in all types of wall and comes without electrical connection. It is available with two constant volume inner panels (22 m<sup>3</sup>/h and 30 m<sup>3</sup>/h) as well as a humidity-controlled inner panel (6 – 45 m<sup>3</sup>/h).

## Advantages

- High sound-insulation due to integrated sound-insulating element (up to 51 dB standard sound level difference)
- Humidity-controlled (with ZLA 125 IB HY) or constant supply air volume (with ZLA 125 IB 22 + 30)
- Universally useable in all wall types
- Particularly installation-friendly due to removable plastic telescopic tube for wall thicknesses from 260 to 500 mm
- Low maintenance costs
- Easily replaceable filter
- Completely operating cost-free
- No electrical connection necessary
- Insect screen included in standard scope of delivery

## Function

The humidity-controlled inner panel ZLA 125 IB HY 6 – 45 automatically reacts to varying room humidity levels and then adjust the flow rate in the range from 6 to 45 m<sup>3</sup>/h (at 20 Pa pressure level). See characteristic curve (humidity-controlled). The inner panels ZLA 125 IB 22 and 30 are self-regulating and keep the flow rate constant, even in case of varying differential pressure levels. See characteristic curve (constant supply air volume). All inner panel types also include Iso Coarse 30% filters, which are easy to maintain. The additional components, such as the installation kit and facade panel, are easy to install and include sound-insulating elements for optimal sound insulation. A standard sound level difference of up to 51 dB can be achieved for a wall thickness of 500 mm using an additional sound-insulating element ZLA 125 SE.

## Installation

Installation in wall openings with a diameter of  $\geq 130$  mm. Insert telescopic tube, adjust to wall thickness, foam-seal at a slight angle and secure protective cover. Plaster tube into place and screw on the facade panel from outside. Optional: Insert insect screen in facade panel, insert Iso Coarse 30% filter in inner panel.

**Inner panel 22 m<sup>3</sup>/h**

**ZLA 125 IB 22** Ref. no. 04393  
Inner panel constant volume  
22 m<sup>3</sup>/h made of white plastic,  
Iso Coarse 30% filter.

**ZLA 125 IB 22**



**Dimensions ZLA 125 IB 22/IB 30**

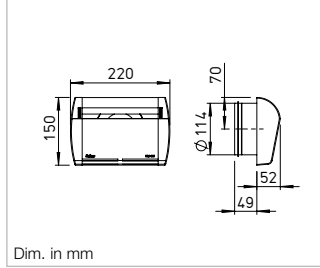

**P-Curves ZLA 125 IB 22/IB 30**

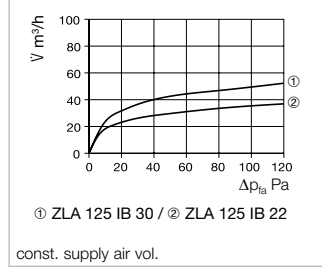

**Inner panel 30 m<sup>3</sup>/h**

**ZLA 125 IB 30** Ref. no. 04394  
Inner panel constant volume  
30 m<sup>3</sup>/h made of white plastic,  
Iso Coarse 30% filter.

**ZLA 125 IB 30**



**ZLA 125 IB HY 6 – 45**



**P-Curves ZLA 125 IB HY 6 – 45**

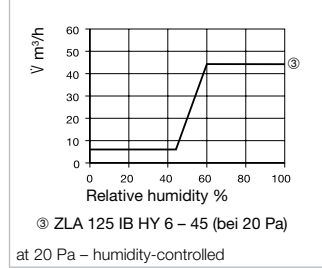

**Inner panel humidity-controlled**

**ZLA 125 IB HY 6 – 45** Nr. 04395  
Inner panel humidity-controlled  
made of white plastic, Iso Coarse  
30% filter.

**Installation kit**

**ZLA 125 RS** Ref. no. 04396  
Telescopic tube 260 – 500 mm  
made of white plastic, incl.  
sound-insulating element 200 mm  
made of melamine resin foam,  
incl. 2x protective covers.

**ZLA 125 RS**



**Dimensions ZLA 125 RS**

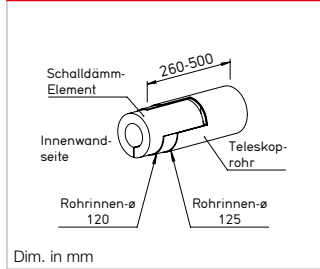

**Sound-insulating element**

**ZLA 125 SE** Ref. no. 04397  
Sound-insulating element 200 mm  
made of melamine resin foam. Can  
also be used for wall thicknesses  
≥ 300 mm.

**ZLA 125 SE**



**Dimensions ZLA 125 SE**

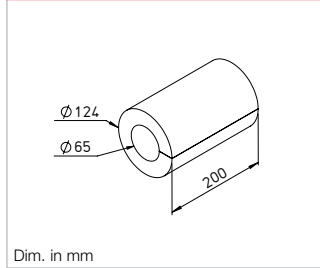

**Facade panel**

**ZLA 125 FB** Ref. no. 04398  
Facade panel made of white  
plastic for external use, insect  
screen made of stainless steel.

**ZLA 125 FB**



**Dimensions ZLA 125 FB**

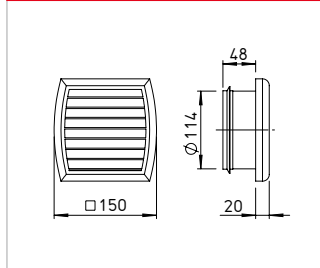

Technical data		Set ZLA 125		
		ZLA 125 IB 22 + ZLA 125 RS + ZLA 125 FB	ZLA 125 IB 30 + ZLA 125 RS + ZLA 125 FB	ZLA 125 IB HY 6-45 + ZLA 125 RS + ZLA 125 FB
Flow rate at 20 Pa	m <sup>3</sup> /h	22	30	6 – 45
Standard sound level diff. D <sub>n,e,w</sub>	dB	56	55	54
Standard sound level diff. D <sub>n,e,w</sub> incl. ZLA 125 SE	dB	59	58	57
Pipe DN	Ø in mm	125	125	125
Core drilling	Ø in mm	≥ 130	≥ 130	≥ 130
Weight	kg	1.15	1.15	1.13

**• Spare air filter**  
**ELF-DLV 125** Ref. no. 03058  
5 spare filters Iso Coarse 30%  
for inner panel.

**• Order info:**  
A complete supply air unit  
consists of an inner panel,  
an installation kit and a facade  
panel. Sound-insulating elements  
are used for wall thicknesses  
≥ 300 mm.

# Invisible in the window soffit. ZLA LE.

The soffit element ZLA LE diverts the supply air inside the thermal insulation system by 90° in the window soffit. The highlight: No components can be seen on the outer facade, apart from the grille in the window bar. ZLA LE can be used for pipe diameters 100 and 125 mm and it can be individually configured: Select the wall grille that meets your requirements and the desired inner panel in addition to the installation kit. Optional components, such as sound-insulating elements, insect screens and volume stabiliser are available for further adaptation to the field of application.

Install. example  
DN 100 mm

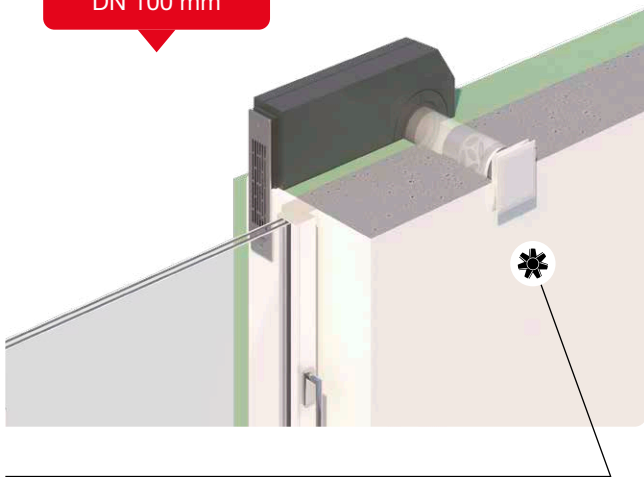

Installation kit soffit ZRL 100 with design ventilation valve DLV 100 and optional sound-insulating volume element SVE 100. The flow rate can be manually adjusted using the design ventilation valve.

Install. example  
DN 125 mm

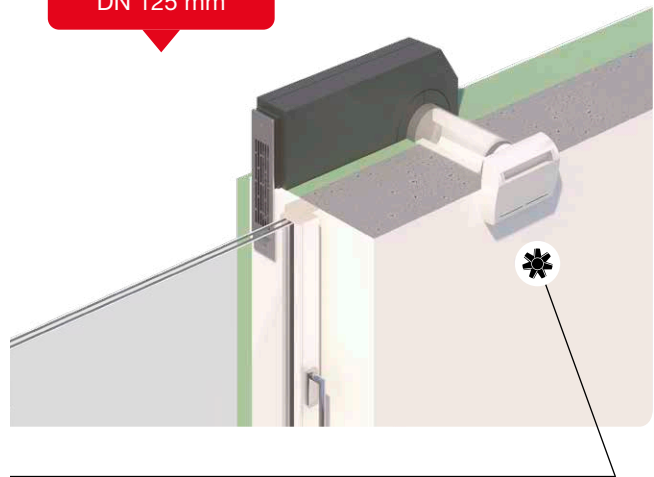

Installation kit soffit ZRL 125 with inner panel ZLA 125 IB and optional sound-insulating element ZLA 125 SE. The inner panels regulate the flow rate or keep it constant depending on the humidity and design.

## ■ Soffit element

ZRL 100 / ZRL 125



**Installation kit Soffit**  
**ZRL 100** Ref. no. 07459  
**ZRL 125** Ref. no. 07462  
Consisting of telescopic tube 260–500 mm (DN 100 / DN 125) and EPP soffit channel (fire protection class B1). Incl. 2 plaster covers for inside and outside, for protection against contamination in the shell construction phase. Flexible installation left or right of window possible without modification.

KWL 45 SEL



**Sound-insulating elem. Soffit**  
**KWL 45 SEL** Ref. no. 04170  
Sound-insulating element for reducing the through sound. For installation in the soffit channel. Up to 3 sound-insulating elements can be used one complete soffit channel.

KWL 45 LG / LG-B / LG-W



**Wall grille Soffit element**  
**KWL 45 LG** Ref. no. 04167  
Stainless steel wall grille with integrated condensate drainage. Includes bonded seal.  
**KWL 45 LG-B** Ref. no. 04168  
Wall grille with additional coating for use in environments with heavy air contamination or high salt concentration in the air (coastal areas).  
**KWL 45 LG-W** Ref. no. 04169  
Wall grille with additional white coating.

KWL 45 ISL



**Insect screen**  
**KWL 45 ISL** Ref. no. 03004  
Stainless steel insect screen for soffit element. Also suitable for retrofitting.

### Sound-insulating element

**SVE 100** Ref. no. 08310  
**SVE 125** Ref. no. 08311

For simple and cost-effective volume control, pressure control and sound insulation in ventilation systems through insertion in the ducting. Up to 9 sound-insulating volume elements can be used with the corresponding wall thickness.

### SVE 100 / SVE 125



### ZLA 125 SE



only for DN 125

### Schalldämm-Element

**ZLA 125 SE** Ref. no. 04397

Schalldämmelement 200 mm aus Melaminharz-Schaumstoff für den Einsatz in das Teleskoprohr. Bei entsprechender Wandstärke sind bis zu 2 Schalldämmelemente einsetzbar.

### Flow rate stabiliser

**VKH 100/15-50** Ref. no. 00002

Automatic flow rate stabiliser VKH (DN 100) for insertion in the telescopic tube. The flow rate can be set between 15 – 50 m<sup>3</sup>/h by simply moving the adjustment unit.

### VKH 100/15-50



only for DN 100

### Design ventilation valve

**DLV 100** Ref. no. 03039

**DLV 125** Ref. no. 03049

Design ventilation valve for supply air operation, DN 100 / DN 125, adjustable. With closed front and integrated Iso Coarse 30% filter.

### DLV 100 / DLV 125



### Performance curves DLV 100

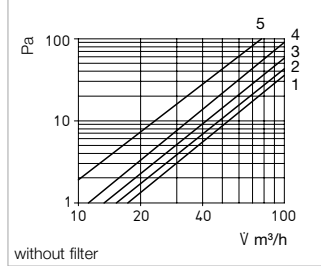

without filter

### Performance curves DLV 125

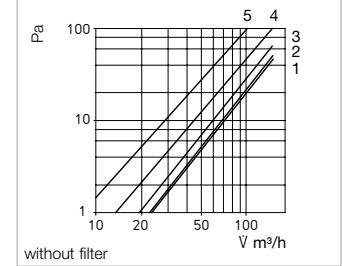

without filter

### Inner panel

**ZLA 125 IB 22** Ref. no. 04393

Inner panel constant volume 22 m<sup>3</sup>/h made of white plastic, incl. Iso Coarse 30% filter.

**ZLA 125 IB 30** Ref. no. 04394

Inner panel constant volume 30 m<sup>3</sup>/h made of white plastic, incl. Iso Coarse 30% filter.

**ZLA 125 IB HY 6-45** Nr. 04395

Inner panel humidity-controlled betw. 6 – 45 m<sup>3</sup>/h made of white plastic, incl. Iso Coarse 30% filter.

### ZLA 125 IB



only for DN 125

### P-Curves ZLA 125 IB 22/IB 30

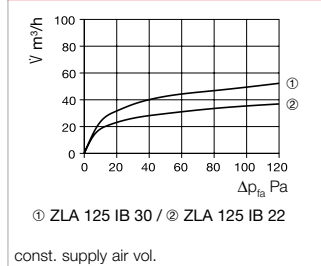

① ZLA 125 IB 30 / ② ZLA 125 IB 22

const. supply air vol.

### P-Curves ZLA 125 IB HY 6 – 45

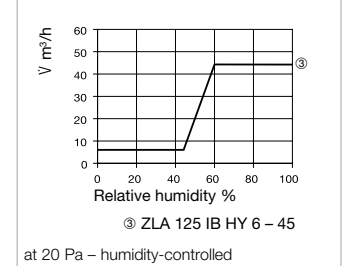

③ ZLA 125 IB HY 6 – 45

at 20 Pa – humidity-controlled

### Technical data: Basic components

Set: ZLA LE basic systems		ZRL 100 + KWL 45 LG + DLV 100	ZRL 125 + KWL 45 LG + DLV 125	ZRL 125 + KWL 45 LG + ZLA 125 IB 22	ZRL 125 + KWL 45 LG + ZLA 125 IB 30	ZRL 125 + KWL 45 LG + ZLA 125 IB HY 6-45
Flow rate at 20 Pa	m <sup>3</sup> /h	Adjustable 33–75	Adjustable 18-120	Constant volume 22	Constant volume 30	Humid.-control. 6–45
Standard sound level difference D <sub>n,e,w</sub>	dB	41	40	49	48	47
Max. standard sound level diff. with optional sound-insulat. elements		54	63	65	64	63
Pipe DN	Ø in mm	100	125	125	125	125
Core drilling	Ø in mm	≥ 115	≥ 130	≥ 130	≥ 130	≥ 130

### Technical data: Optional accessories

Add. components (optional)		VKH 100/15-50	KWL 45 SEL	SVE 100	SVE 125	ZLA 125 SE
Standard sound level difference D <sub>n,e,w</sub>	dB	–	The exact values for each configuration can be found at heliosselect.de in the "Declaration of performance" document for reference numbers 07459 and 07462.			
Pipe DN	Ø in mm	100	–	100	125	125
Length	mm	70	94	50	50	200

# A perfect team.



**ELS and  
EcoVent Verso:**  
Cast from the same  
mould. Optimally  
coordinated technology.

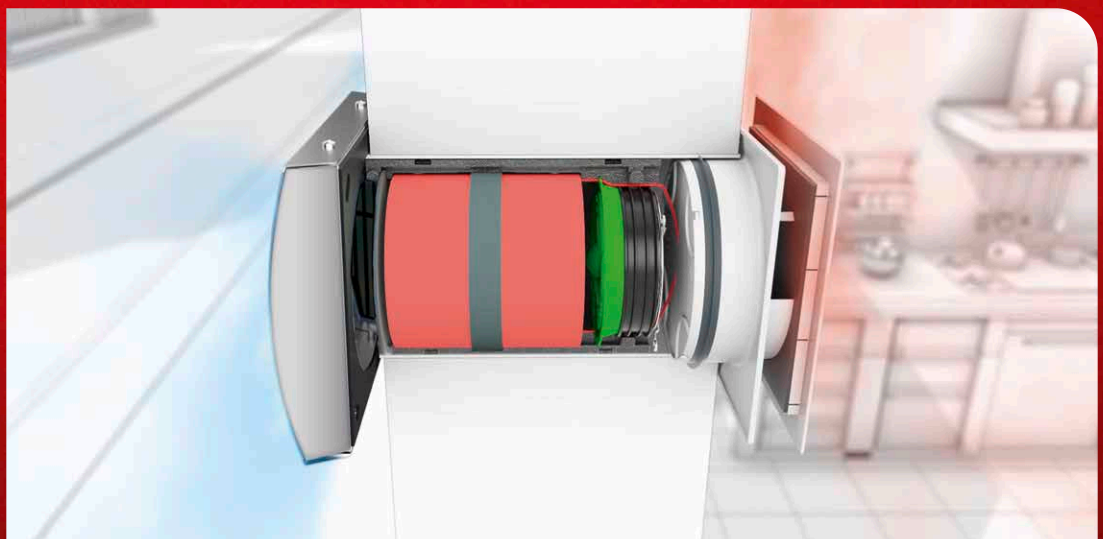

# More efficient in combination. ELS and EcoVent Verso.

## The dream team for decentralised domestic ventilation with heat recovery.

Controlled domestic ventilation with heat recovery (KWL<sup>®</sup>) is virtually indispensable in modern single family homes and apartment buildings. Whether it's a new building or renovation – ventilation measures not only improve the indoor environment, but also the energy balance. Particularly if there is limited space available, decentralised solutions present themselves. EcoVent Verso opens up a wide spectrum through the variable applications and various combinations with other ventilation units.

The heat recovery of the EcoVent Verso takes place in reverse operation, whereby supply and extract air phases alternate. During the extract air phase, the ceramic heat accumulator absorbs and stores the heat from the room air. During the subsequent supply air operation, the fresh outside air flows through the ceramic accumulator and absorbs the heat, so that pre-heated fresh air flows into the living space. At least two push-pull working units form a functioning ventilation system, whereby multiple EcoVent Verso are installed depending on the air requirement of the residential unit.

An intelligent control system allows the optimal coordination of the individual flow rates – even with an uneven number of units. The commissioning is also particularly simple: The settings can be adjusted directly via a PC or laptop thanks to the clever software. Quick and uncomplicated. **Particularly efficient:** The combination of extract air fans ultraSilence<sup>®</sup> ELS with decentralised ventilation units with heat recovery EcoVent Verso. These can switch from heat recovery to supply air mode in connection with an extension module. Outside air openings are therefore no longer required, because the extract air units are reliably supplied with fresh air.

### Your advantages:

- Compact dimensions for external wall installation in case of minimal space.
- Economical EC fans for maximum energy efficiency.
- Heat recovery efficiency of up to 88 % (according to latest DIBt test procedure).
- Comfort controls, can be connected to extract air systems for combined ventilation operation.
- Simple commissioning through connection of control elements to PC or laptop.
- Multi-award-winning design, perfectly matches the Helios extract air solutions ultraSilence<sup>®</sup> ELS and MiniVent<sup>®</sup> M1.

### At least two units form a ventilation unit.

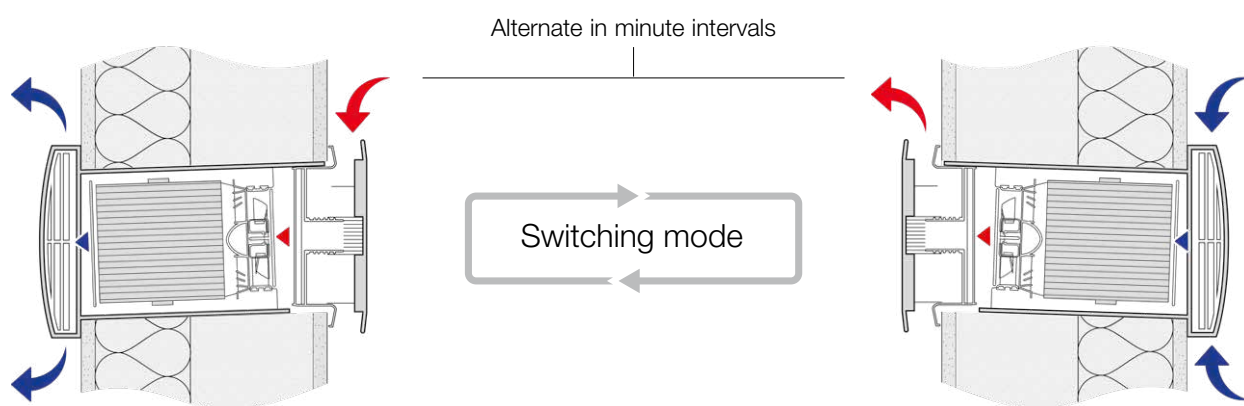

#### Extract air

During the extract air phase, the ceramic accumulator absorbs and stores the heat from the room air (storage charging).

#### Supply air

During the supply air phase, the fresh outside air absorbs the heat from the ceramic accumulator and this pre-heated air flows into the room.

# Example 4-room apartment. Combined ventilation with EcoVent Verso.

## The combination that makes the difference.

EcoVent Verso can be operated in combination with **ultraSilence® ELS** using the innovative controls and an extension module.

This form of intelligent ventilation is particularly suitable for apartment layouts, where there are inner bathrooms and extract ventilation is carried out by a mono tube ventilation system. As soon as the extract air fans become active, the extension module reacts and adapts the EcoVent operating mode. For example, this is how it automatically switches to supply air operation and ensures a balanced air balance throughout the apartment.

## There are two options for combined ventilation operation:

- Design ECO-COMBI
- Design DIN-COMBI

With regard to the **Eco-Combi solution**, a user-independent extract air system is used instead of window ventilation. With regard to the **DIN-Combi solution**, the heat recovery by means of EcoVent Verso is replaced by an extract air system in extract air rooms. This is normally realised as a demand-based system. Furthermore, the EcoVent Verso units ensure the supply and extract ventilation with heat recovery in the supply air rooms. If an extract air fan is activated, it takes on the backflow of outside air without heat recovery. If the extract air fan deactivates again, the units return to heat recovery mode. A sufficient supply of air is fully automatically ensured in this way.

**The advantage for the residents is that the ventilation functions fully automatically and user-independently.**

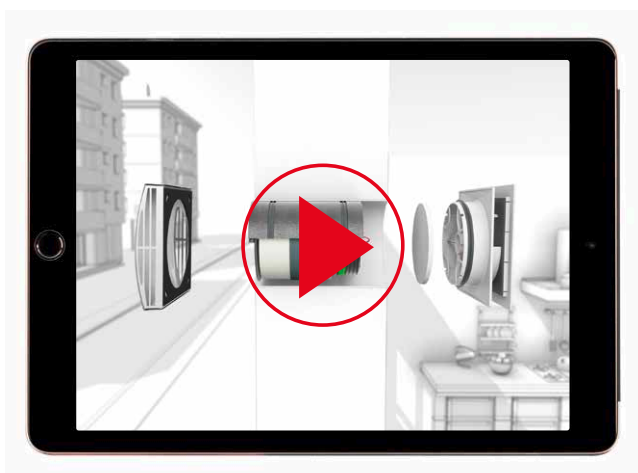

Play now



Learn about the many possibilities offered by EcoVent Verso now on our YouTube channel.



## Example floor plan

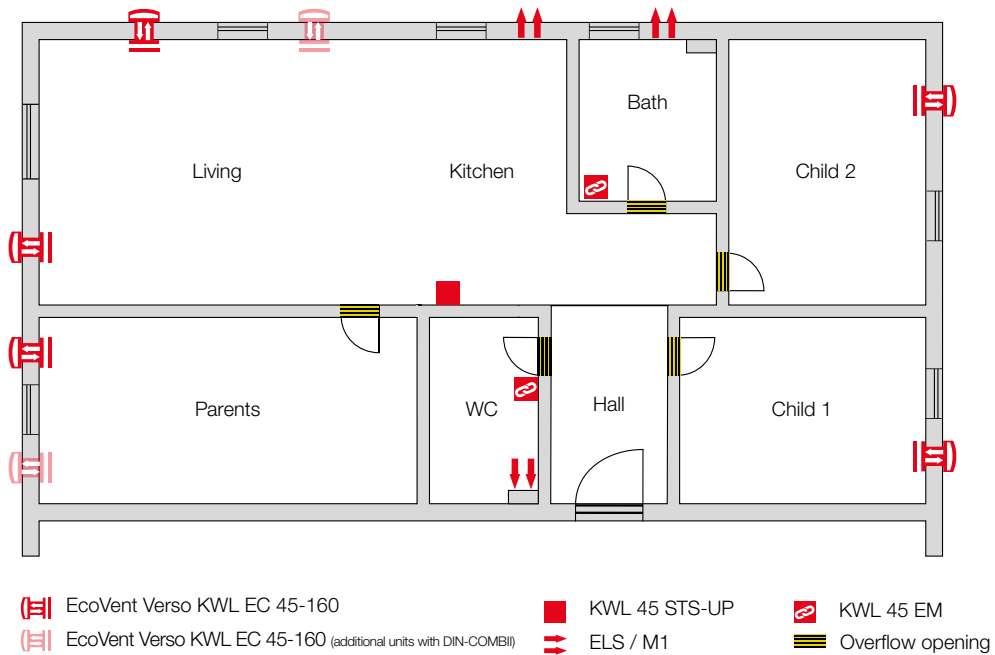







## Bill of quantities System example 4-room apartment



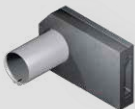
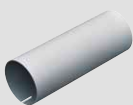



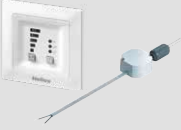
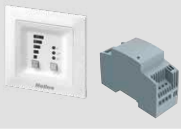

Ref. no.	Type	Name	Design: ECO-KOMBI	Design: DIN-KOMBI*
Living room, bedroom and childrens room:				
09361	KWL EC 45-160	Ventilation unit with inner panel	5 pcs.	7 pcs.
08160	KWL 45-160 LE-RP	Soffit element and wall sleeve	5 pcs.	7 pcs.
03006	KWL 45 STS-UP	Control set	1 pcs.	1 pcs.
04167	KWL 45 LG	Soffit grill	1 pcs.	1 pcs.
03008	KWL 45 SNU	Switching power supply UP	-	1 pcs.
03012	KWL 45 EM	Extension module	3 pcs.	3 pcs.
Kitchen:				
09361	KWL EC 45-160	Ventilation unit with inner panel	-	-
08160	KWL 45-160 LE-RP	Soffit element and wall sleeve	-	-
03006	KWL 45 STS-UP	Control set	-	-
04167	KWL 45 LG	Soffit grill	1 pcs.	1 pcs.
06175	M1 / 100 F	Extract air fan	1 pcs.	1 pcs.
00717	WES 100	Wall installation kit for M1	1 pcs.	1 pcs.
Bathroom:				
09361	KWL EC 45-160	Ventilation unit with inner panel	-	-
08160	KWL 45-160 LE-RP	Soffit element and wall sleeve	-	-
03006	KWL 45 STS-UP	Control set	-	-
04167	KWL 45 LG	Soffit grill	1 pcs.	1 pcs.
06175	M1 / 100 F	Extract air fan	1 pcs.	1 pcs.
00717	WES 100	Wall installation kit for M1	1 pcs.	1 pcs.
WC:				
09361	KWL EC 45-160	Ventilation unit with inner panel	-	-
08160	KWL 45-160 LE-RP	Soffit element and wall sleeve	-	-
03006	KWL 45 STS-UP	Control set	-	-
04167	KWL 45 LG	Soffit grill	1 pcs.	1 pcs.
08131	ELS-V 60	Extract air fan	1 pcs.	1 pcs.
08111	ELS-GU	Flush-mounted casing for ELS-V 60	1 pcs.	1 pcs.

\* With regard to DIN variants, flow rates are in accordance with nominal ventilation (DIN 1946-6)

# At a glance.

## All EcoVent Verso components.

Product image	Ref. no.	Type	Name	Description
<b>■ Sets and components for shell construction</b>				
	08160	KWL 45-160 LE-RP	Soffit element and wall sleeve	Consists of a 500 mm plastic wall sleeve and EPP soffit element, fire protection class B1 (hardly inflammable). Incl. 2x protection covers for the inside and outside of the wall, to protect against soiling in the shell construction phase. Condensate wedge to fix the wall sleeve with gradient for safe condensate drainage.
	09319	KWL 45-160 WH	Wall installation sleeve 500 mm	Plastic, diameter 160 mm (length 500 mm). Incl. 2x protection covers for the inside and outside of the wall, to protect against soiling in the shell construction phase. Condensate wedges to fix the wall sleeve with gradient for safe condensate drainage.
	09320	KWL 45-160 WH-L	Wall installation sleeve 800 mm	Like KWL 45-160 WH, but length 800 mm.
<b>■ Unit</b>				
	09361	KWL EC 45-160	Unit	Consists of design internal panel with filter, ceramic heat exchanger, flow straighteners, external protection grille, EC axial fan with protection grille, removal tool (cord) and EPP half shell base frame.
<b>■ Facade panels and grilles</b>				
	09321	KWL 45-160 FB-E	Standard	Stainless steel panel for external wall.
	09322	KWL 45-160 FB-B	With additional coating	For use in environments with heavy air pollution or high salt concentration in the air.
	09323	KWL 45-160 FB-W	Colour: White	Facade panel with white coating.
	09324	KWL 45-160 FBT-E	Deep facade panel	For the installation of KWL EC 45-160 in external wall thicknesses from 250 – 300 mm. Incl. packing.
	09326	KWL 45-160 FBT-B	With additional coating	With transparent powder-painting for use in environments with heavy air pollution or high salt concentration in the air.
	09340	KWL 45-160 FBT-W	Colour: White	Facade panel with white coating.
	04167	KWL 45 LG	Wall grille Standard	Stainless steel wall grille with integrated condensate drain. Includes bonded seal.
	04168	KWL 45 LG-B	With additional coating	Soffit grill with additional coating for use in environments with heavy air pollution or high salt concentration in the air (Coastal).
	04169	KWL 45 LG-W	Colour: White	Wall grille with white coating.
	03004	KWL 45 ISL	Insect screen	For soffit element (KWL 45-160 LE-RP), suitable for retrofitting. Material: stainless steel. Dimensions: 48 x 203 x 4 mm (W x H x D)

Produktbild	Bestell-Nr.	Type	Bezeichnung	Beschreibung
<b>■ Steuerung</b>				
	03006	KWL 45 STS-UP	Control set UP (flush-mounted)	Consists of control element KWL 45 BEU and switching power supply KWL 45 SNU for installation in flush-mounted box. Enables the connection of up to 6 units. In case of more than 6 units, an additional KWL 45 SNU is required. Max. 8 units per control element possible.
	04270	KWL-APG	Control set APG (Surface-mounted)	Casing for surface mounting
	03007	KWL 45 STS-HS	Control set HS (DIN rail)	Consists of control element KWL 45 BEU and switching power supply KWL 45 SNH for DIN rails (2 TE). Enables the connection of up to 4 units. In case of more than 4 units, an additional KWL 45 SNH is required. Max. 8 units per control element possible.
	03008	KWL 45 SNU	Switching power supply UP (flush-mounted)	For extending the control set KWL 45 STS-UP from 6 to 8 units. Input: 230 V AC, 50/60 Hz. Output: 12 V DC / 1,9 A. Output voltage to SELV protection class III. Electrical safety according to DIN EN 60335-1. Tested according to EMC 2014/30/EU.
	03001	KWL 45 SNH	Switching power supply HS (DIN rail)	For extending the control set KWL 45 STS-HS from 4 to 8 units. Input: 230 V AC, 50/60 Hz. Output: 12 V DC / 1.5 A for installation in the distribution box (2 TE). Output voltage to SELV protection class III. Electrical safety according to DIN EN 60335-1. Meets EMC requirements according to directive 2014/30/EU.
	01359	HY 3	Hygrostat	For connection to the external contact of the control element. Attention: Parallel use with the KWL-EM is not possible. Dimensions: 76×76×34 mm (H × W × D)
	01360	HY 3 SI	Hygrostat with internal scale	Like HY 3, but with internal scale.
	03012	KWL 45 EM	Extension module	For the combined operation of an extract air system, e.g. according to DIN 18017, T3 with KWL EC 45-160 (combi-ventilation) to use the potential-free contact.
<b>■ Zubehör</b>				
	09362	KWL 45-160 SE	Sound insulation element	For installation in wall sleeve (max. 4 pcs. for 500 mm). Material: Thermoset foam made of melamine resin. Fire protection class: B1 (hardly inflammable). Increases the sound insulation against external noise by 2 dB (D <sub>n,e,w</sub> ). Dimensions: Ø 156 mm; height: 50 mm.
	04170	KWL 45 SEL	Sound insulation element for soffit element	For use in the soffit channel (max. 3 pcs. in shortened channel). Material: Thermoset foam made of melamine resin, stainless steel. fire protection class B1. Increases the sound insulation against external noise by 2 dB (D <sub>n,e,w</sub> ). Dimensions: 94 x 180 x 32 mm (W x H x D).
	09302	KWL 45-160 WS	Wall stone length 365 mm	Installation tool for brickwork. Made from EPS, fire protection class B1 (hardly inflammable). Replaces the otherwise necessary core drilling.
	09306	KWL 45-160 WS-L	Wall stone length 490 mm	Like KWL 45-160 WS, but with length 490 mm.
	09366	ELF-KWL 45-160/3/3	Replacement air filter	Consists of 2 pc. ISO Coarse 50% filter.

# So that everything runs perfectly: The wiring diagrams.

## ■ ELS Standard



<p>2] 60 m<sup>3</sup>/h</p>	Type	<b>ELS-V 60</b>
	Ref. no.	08131
	Wiring diagram no.	869
	Electrical psupply line in mm <sup>2</sup>	2 x 1,5

<p>3] 60 m<sup>3</sup>/h 2] 40 m<sup>3</sup>/h 1] 15 m<sup>3</sup>/h</p>	Type	<b>ELS EC 60/40/15</b>
	Ref. no.	06359
	Wiring diagram no.	1200
	Electrical psupply line in mm <sup>2</sup>	5 x 1,5

<p>a) Rückspg.! siehe MBV 2] 60 m<sup>3</sup>/h 1] 35 m<sup>3</sup>/h</p>	Type	<b>ELS-V 60/35</b>
	Ref. no.	08133
	Wiring diagram no.	871
	Electrical psupply line in mm <sup>2</sup>	3 x 1,5

<p>3] 60 m<sup>3</sup>/h 2] 45 m<sup>3</sup>/h 1] 25 m<sup>3</sup>/h</p>	Type	<b>ELS EC 60/45/25</b>
	Ref. no.	06358
	Wiring diagram no.	1199
	Electrical psupply line in mm <sup>2</sup>	5 x 1,5

<p>3] 100 m<sup>3</sup>/h</p>	Type	<b>ELS-V 100</b>
	Ref. no.	08132
	Wiring diagram no.	870
	Electrical psupply line in mm <sup>2</sup>	2 x 1,5

<p>3] 100 m<sup>3</sup>/h</p>	Type	<b>ELS EC 100</b>
	Ref. no.	06417
	Wiring diagram no.	1160
	Electrical psupply line in mm <sup>2</sup>	3 x 1,5

<p>a) Rückspg.! siehe MBV 3] 100 m<sup>3</sup>/h 2] 60 m<sup>3</sup>/h 1] 35 m<sup>3</sup>/h</p>	Type	<b>ELS-V 100/60/35</b>
	Ref. no.	08136
	Wiring diagram no.	874
	Electrical psupply line in mm <sup>2</sup>	4 x 1,5

<p>3] 100 m<sup>3</sup>/h 1] 35 m<sup>3</sup>/h</p>	Type	<b>ELS EC 100/35</b>
	Ref. no.	06420
	Wiring diagram no.	1162
	Electrical psupply line in mm <sup>2</sup>	4 x 1,5

<p>2] 60 m<sup>3</sup>/h</p>	Type	<b>ELS EC 60</b>
	Ref. no.	06427
	Wiring diagram no.	1159
	Electrical psupply line in mm <sup>2</sup>	3 x 1,5

<p>3] 100 m<sup>3</sup>/h 2] 60 m<sup>3</sup>/h</p>	Type	<b>ELS EC 100/60</b>
	Ref. no.	06418
	Wiring diagram no.	1163
	Electrical psupply line in mm <sup>2</sup>	4 x 1,5

<p>2] 60 m<sup>3</sup>/h 1] 35 m<sup>3</sup>/h</p>	Type	<b>ELS EC 60/35</b>
	Ref. no.	06428
	Wiring diagram no.	1161
	Electrical psupply line in mm <sup>2</sup>	4 x 1,5

<p>3] 100 m<sup>3</sup>/h 2] 60 m<sup>3</sup>/h 1] 35 m<sup>3</sup>/h</p>	Type	<b>ELS EC 100/60/35</b>
	Ref. no.	06419
	Wiring diagram no.	1164
	Electrical psupply line in mm <sup>2</sup>	5 x 1,5

Electrical connection: 230 V~, 50 Hz, NYM-O / Protection class II without PE

■ ELS with overrun and adjustable overrun



	Type <b>ELS-VN 60</b> Ref. no. 08137 Wiring diagram no. 875 Electrical psupply line in mm² 3 x 1,5			Type <b>ELS EC 60/15 N</b> Ref. no. 40099 Wiring diagram no. 1459 Electrical psupply line in mm² 4 x 1,5	
	Type <b>ELS-VN 60/35</b> Ref. no. 08139 Wiring diagram no. 877 Electrical psupply line in mm² 4 x 1,5			Type <b>ELS EC 60/35 N</b> Ref. no. 06504 Wiring diagram no. 1188 Electrical psupply line in mm² 4 x 1,5	
	Type <b>ELS-VN 100</b> Ref. no. 08138 Wiring diagram no. 876 Electrical psupply line in mm² 3 x 1,5			Type <b>ELS EC 100 N</b> Ref. no. 06421 Wiring diagram no. 1187 Electrical psupply line in mm² 3 x 1,5	
	Type <b>ELS-VN 100/60</b> Ref. no. 08141 Wiring diagram no. 879 Electrical psupply line in mm² 4 x 1,5			Type <b>ELS EC 100/35 N</b> Ref. no. 06505 Wiring diagram no. 1189 Electrical psupply line in mm² 4 x 1,5	
	Type <b>ELS-VNC 60</b> Ref. no. 08143 Wiring diagram no. 881 Electrical psupply line in mm² 3 x 1,5 / 4 x 1,5*			Type <b>ELS EC 100/60 N</b> Ref. no. 06498 Wiring diagram no. 1190 Electrical psupply line in mm² 4 x 1,5	
	Type <b>ELS-VNC 100</b> Ref. no. 08144 Wiring diagram no. 882 Electrical psupply line in mm² 3 x 1,5 / 4 x 1,5*			Type <b>ELS EC 100/60/35 N</b> Ref. no. 06430 Wiring diagram no. 1191 Electrical psupply line in mm² 5 x 1,5	
	Type <b>ELS EC 40/60 N</b> Ref. no. 40098 Wiring diagram no. 1398 Electrical psupply line in mm² 4 x 1,5			Type <b>ELS EC 40/15/60 NC</b> Ref. no. 40102 Wiring diagram no. 1460 Electrical psupply line in mm² 5 x 1,5	
	Type <b>ELS EC 60 N</b> Ref. no. 06429 Wiring diagram no. 1186 Electrical psupply line in mm² 3 x 1,5			Type <b>ELS EC 45/25/60 NC</b> Ref. no. 40114 Wiring diagram no. 1461 Electrical psupply line in mm² 5 x 1,5	

\* For deactivation of Interval function

Electrical connection: 230 V~, 50 Hz, NYM-O / Protection class II without

## ■ ELS with overrun and adjustable overrun



<p>2) 60 m³/h</p> <p>a) manuell Ein b) Automatik deaktivieren</p>	Type	<b>ELS EC 60 NC</b>
	Ref. no.	06402
	Wiring diagram no.	1165
	Electrical psupply line in mm²	3 x 1,5

<p>3) 100 m³/h 2) 60 m³/h</p> <p>a) manuell Ein b) Automatik deaktivieren</p>	Type	<b>ELS EC 100/60 NC</b>
	Ref. no.	06399
	Wiring diagram no.	1169
	Electrical psupply line in mm²	4 x 1,5

<p>3) 60 m³/h 2) 60 m³/h 1) 15 m³/h</p> <p>a) manuell Ein b) Automatik deaktivieren</p>	Type	<b>ELS EC 60/15 NC</b>
	Ref. no.	40169
	Wiring diagram no.	1462
	Electrical psupply line in mm²	4 x 1,5

<p>3) 100 m³/h 2) 60 m³/h 1) 35 m³/h</p> <p>a) manuell Ein</p>	Type	<b>ELS EC 100/60/35 NC</b>
	Ref. no.	06400
	Wiring diagram no.	1170
	Electrical psupply line in mm²	5 x 1,5

<p>2) 60 m³/h 1) 35 m³/h</p> <p>a) manuell Ein b) Automatik deaktivieren</p>	Type	<b>ELS EC 60/35 NC</b>
	Ref. no.	06403
	Wiring diagram no.	1167
	Electrical psupply line in mm²	4 x 1,5

## ■ ELS with automatic humidity control

<p>3) 60 m³/h 2) 40 m³/h 1) 15 m³/h</p> <p>a) manuell Ein</p>	Type	<b>ELS EC 60/40/15 NC</b>
	Ref. no.	06356
	Wiring diagram no.	1198
	Electrical psupply line in mm²	5 x 1,5

<p>2) 60 m³/h</p> <p>b) manuell Ein c) Automatik deaktivieren</p>	Type	<b>ELS-VF 60</b>
	Ref. no.	08161
	Wiring diagram no.	881
	Electrical psupply line in mm²	3 x 1,5 / 4 x 1,5*

<p>3) 60 m³/h 2) 45 m³/h 1) 25 m³/h</p> <p>a) manuell Ein</p>	Type	<b>ELS EC 60/45/25 NC</b>
	Ref. no.	06355
	Wiring diagram no.	1197
	Electrical psupply line in mm²	5 x 1,5

<p>2) 60 m³/h 1) 35 m³/h</p> <p>a) Rückspg.! siehe MBV b) manuell Ein c) Automatik deaktivieren</p>	Type	<b>ELS-VF 60/35</b>
	Ref. no.	08163
	Wiring diagram no.	883
	Electrical psupply line in mm²	4 x 1,5 / 5 x 1,5*

<p>3) 100 m³/h</p> <p>a) manuell Ein b) Automatik deaktivieren</p>	Type	<b>ELS EC 100 NC</b>
	Ref. no.	06398
	Wiring diagram no.	1166
	Electrical psupply line in mm²	3 x 1,5

<p>3) 100 m³/h 2) 60 m³/h 1) 35 m³/h</p> <p>a) Rückspg.! siehe MBV b) manuell Ein</p>	Type	<b>ELS-VF 100/60/35</b>
	Ref. no.	08166
	Wiring diagram no.	886
	Electrical psupply line in mm²	5 x 1,5

<p>3) 100 m³/h 1) 35 m³/h</p> <p>a) manuell Ein b) Automatik deaktivieren</p>	Type	<b>ELS EC 100/35 NC</b>
	Ref. no.	06401
	Wiring diagram no.	1168
	Electrical psupply line in mm²	4 x 1,5

<p>3) 60 m³/h 2) 40 m³/h 1) 15 m³/h</p> <p>a) manuell Ein</p>	Type	<b>ELS EC 40/15/60 F</b>
	Ref. no.	40170
	Wiring diagram no.	1463
	Electrical psupply line in mm²	5 x 1,5

\* For deactivation of Interval function

Electrical connection: 230 V~, 50 Hz, NYM-O / Protection class II without PE



	Type	<b>ELS EC 40/20/60 F</b>
	Ref. no.	40171
	Wiring diagram no.	1464
	Electrical supply line in mm <sup>2</sup>	5 x 1,5

3 60 m<sup>3</sup>/h  
 2 40 m<sup>3</sup>/h  
 1 20 m<sup>3</sup>/h  
 a) manuell Ein

	Type	<b>ELS EC 100 F</b>
	Ref. no.	06404
	Wiring diagram no.	1172
	Electrical supply line in mm <sup>2</sup>	3 x 1,5

3 100 m<sup>3</sup>/h  
 a) manuell Ein  
 b) Automatik deaktivieren

	Type	<b>ELS EC 45/25/60 F</b>
	Ref. no.	40172
	Wiring diagram no.	1465
	Electrical supply line in mm <sup>2</sup>	5 x 1,5

3 60 m<sup>3</sup>/h  
 2 45 m<sup>3</sup>/h  
 1 25 m<sup>3</sup>/h  
 a) manuell Ein

	Type	<b>ELS EC 100/35 F</b>
	Ref. no.	06407
	Wiring diagram no.	1174
	Electrical supply line in mm <sup>2</sup>	4 x 1,5

3 100 m<sup>3</sup>/h  
 2 35 m<sup>3</sup>/h  
 1 35 m<sup>3</sup>/h  
 a) manuell Ein  
 b) Automatik deaktivieren

	Type	<b>ELS EC 60 F</b>
	Ref. no.	06408
	Wiring diagram no.	1171
	Electrical supply line in mm <sup>2</sup>	3 x 1,5

2 60 m<sup>3</sup>/h  
 a) manuell Ein  
 b) Automatik deaktivieren

	Type	<b>ELS EC 100/60 F</b>
	Ref. no.	06405
	Wiring diagram no.	1175
	Electrical supply line in mm <sup>2</sup>	4 x 1,5

3 100 m<sup>3</sup>/h  
 2 60 m<sup>3</sup>/h  
 1 60 m<sup>3</sup>/h  
 a) manuell Ein  
 b) Automatik deaktivieren

	Type	<b>ELS EC 60/15 F</b>
	Ref. no.	40173
	Wiring diagram no.	1466
	Electrical supply line in mm <sup>2</sup>	4 x 1,5

3 60 m<sup>3</sup>/h  
 2 60 m<sup>3</sup>/h  
 1 15 m<sup>3</sup>/h  
 a) manuell Ein  
 b) Automatik deaktivieren

	Type	<b>ELS EC 100/60/35 F</b>
	Ref. no.	06406
	Wiring diagram no.	1176
	Electrical supply line in mm <sup>2</sup>	5 x 1,5

3 100 m<sup>3</sup>/h  
 2 60 m<sup>3</sup>/h  
 1 35 m<sup>3</sup>/h  
 a) manuell Ein

	Type	<b>ELS EC 60/35 F</b>
	Ref. no.	06409
	Wiring diagram no.	1173
	Electrical supply line in mm <sup>2</sup>	4 x 1,5

2 60 m<sup>3</sup>/h  
 1 35 m<sup>3</sup>/h  
 a) manuell Ein  
 b) Automatik deaktivieren

	Type	<b>ELS EC 60/40/15 F</b>
	Ref. no.	06374
	Wiring diagram no.	1213
	Electrical supply line in mm <sup>2</sup>	5 x 1,5

3 60 m<sup>3</sup>/h  
 2 40 m<sup>3</sup>/h  
 1 15 m<sup>3</sup>/h  
 a) manuell Ein

	Type	<b>ELS EC 60/45/25 F</b>
	Ref. no.	06365
	Wiring diagram no.	1212
	Electrical supply line in mm <sup>2</sup>	5 x 1,5

3 60 m<sup>3</sup>/h  
 2 45 m<sup>3</sup>/h  
 1 25 m<sup>3</sup>/h  
 a) manuell Ein

\* For deactivation of Interval function

Electrical connection: 230 V~, 50 Hz, NYM-O / Protection class II without PE

## ■ ELS with motion sensor



	Type	<b>ELS-VP 60</b>
	Ref. no.	08149
	Wiring diagram no.	887
	Electrical psupply line in mm <sup>2</sup>	2 x 1,5

	Type	<b>ELS-VP 100</b>
	Ref. no.	08150
	Wiring diagram no.	887
	Electrical psupply line in mm <sup>2</sup>	2 x 1,5

	Type	<b>ELS EC 40/15/60 P</b>
	Ref. no.	40174
	Wiring diagram no.	1467
	Electrical psupply line in mm <sup>2</sup>	5 x 1,5

	Type	<b>ELS EC 45/25/60 P</b>
	Ref. no.	40175
	Wiring diagram no.	1468
	Electrical psupply line in mm <sup>2</sup>	5 x 1,5

	Type	<b>ELS EC 60 P</b>
	Ref. no.	06415
	Wiring diagram no.	1177
	Electrical psupply line in mm <sup>2</sup>	3 x 1,5

	Type	<b>ELS EC 60/35 P</b>
	Ref. no.	06416
	Wiring diagram no.	1179
	Electrical psupply line in mm <sup>2</sup>	4 x 1,5

	Type	<b>ELS EC 100 P</b>
	Ref. no.	06410
	Wiring diagram no.	1178
	Electrical psupply line in mm <sup>2</sup>	3 x 1,5

	Type	<b>ELS EC 100/35 P</b>
	Ref. no.	06414
	Wiring diagram no.	1180
	Electrical psupply line in mm <sup>2</sup>	4 x 1,5

	Type	<b>ELS EC 100/60 P</b>
	Ref. no.	06412
	Wiring diagram no.	1181
	Electrical psupply line in mm <sup>2</sup>	4 x 1,5

	Type	<b>ELS EC 100/60/35 P</b>
	Ref. no.	06413
	Wiring diagram no.	1182
	Electrical psupply line in mm <sup>2</sup>	5 x 1,5

\* For deactivation of Interval function

Electrical connection: 230 V~, 50 Hz, NYM-O / Protection class II without PE







**Helios Ventilatoren GmbH + Co KG** · Lupfenstraße 8 · 78056 Villingen-Schwenningen · Germany  
Phone +49 77 20 / 606 - 0 · Fax +49 77 20 / 606 - 257 · [export@heliosventilatoren.de](mailto:export@heliosventilatoren.de) · [www.heliosventilatoren.de](http://www.heliosventilatoren.de)

KWL® is a registered trademark of Helios Ventilatoren GmbH + Co KG. Copyright ©: Helios Ventilatoren GmbH + Co KG, 78056 VS-Schwenningen, Germany.  
Certified according to ISO 9001/2015. Subject to technical modifications. Illustrations and information are non-binding. Document no. 90 574.844 / 08.21